



Fitting for 2 top-running wooden doors up to 15 kg (33 lbs.), with screwed on or groove mounted running track. Design Mixslide.

Product highlights

-  **Flexibility** Flexible, efficient assembly with single or double running tracks for screw fixing, gluing, or with swivel lugs
-  **Aesthetics** No groove in the base, and no visible guide

Technical specifications

-  Max. 15 kg (33 lbs.)
-  Max. 1400 mm (4'7 1/8")
-  Max. 1000 mm (3'3 3/8")
-  16–19 mm (5/8" to 3/4")

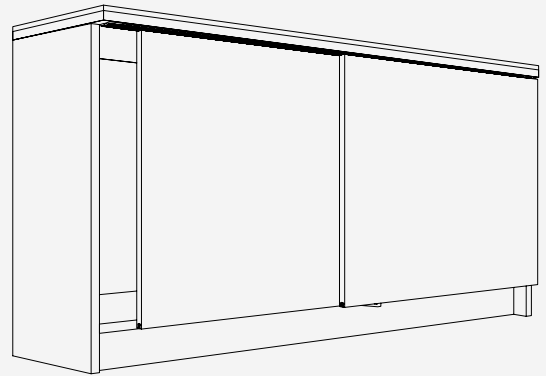



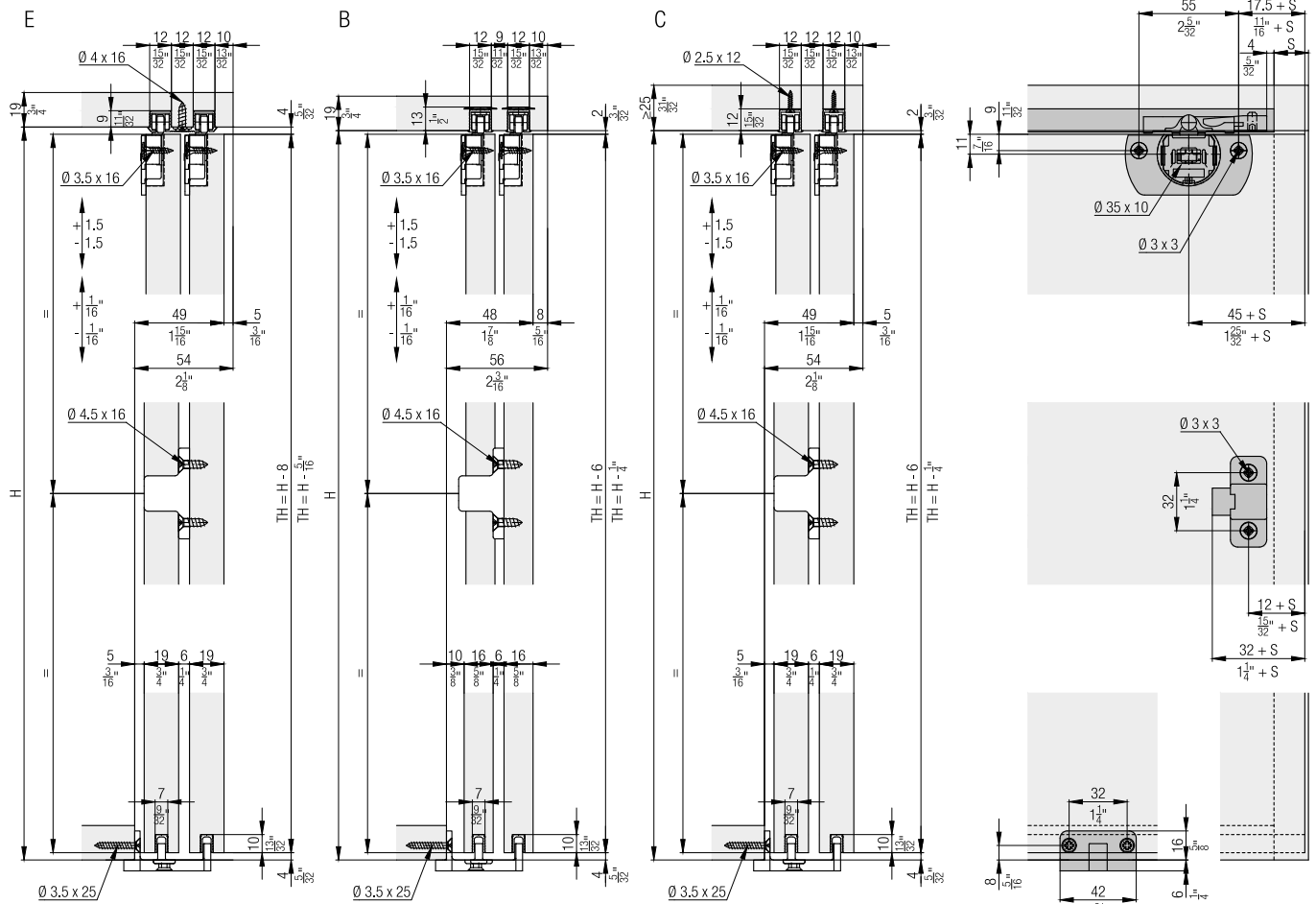





Installation examples





**Set for 2 wooden doors up to 15 kg (33 lbs.),
with height adjustment**

	No.
Hawa Clipo 15 H MS, for 2 doors	053.3115.073

Set consisting of:

		053.3115.073	No.
	Running gear, plastic, anthracite	4	053.3114.071
	Stopper, plastic, gray	2	053.3080.071
	Track support clip, plastic, gray	2	053.3087.001
	Housing, plastic, anthracite	4	053.3112.001
	Fillister head screw, 3.5x16 mm (5/32"x5/8"), steel, zinc-plated	8	766.6052.100
	Door follower, plastic, anthracite	1	053.3217.071
	Flat countersunk head chipboard screw, 4.5x16 mm (3/16"x5/8"), steel, zinc-plated	2	600.0000.478
	Bottom guide, plastic, anthracite	1	053.3232.171
	Flat countersunk head chipboard screw, 3.5x25 mm (5/32"x31/32"), steel, zinc-plated	2	766.5035.125

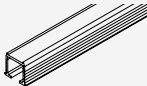
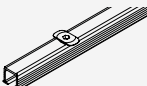
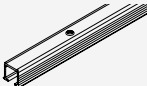
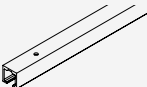
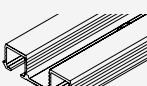
Running tracks

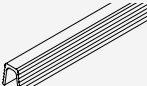

		mm (inch)	No.
	A: Single running track, for press fitting or glueing, aluminum	2,500 (8' 2 7/16")	053.3007.250
		3,500 (11' 5 25/32")	053.3007.350
		6,000 (19' 8 7/32")	053.3007.600
	B: Single running track, with swivel lug, notched on both sides, aluminum (not for hard wood/MDF)	2,500 (8' 2 7/16")	053.3008.250
		3,500 (11' 5 25/32")	053.3008.350
	C: Single running track, notched on both sides, aluminum, pre-drilled	2,500 (8' 2 7/16")	053.3009.250
		3,500 (11' 5 25/32")	053.3009.350
	D: Single running track, aluminum, anodized, pre-drilled	6,000 (19' 8 7/32")	053.3009.600
		2,500 (8' 2 7/16")	053.3035.250
	E: Double running track, aluminum, pre-drilled, only for 19 mm (3/4") doors	3,500 (11' 5 25/32")	053.3035.350
		6,000 (19' 8 7/32")	053.3035.600
		2,500 (8' 2 7/16")	053.3315.250
	E: Double running track, aluminum, pre-drilled, only for 19 mm (3/4") doors	3,500 (11' 5 25/32")	053.3315.350
		6,000 (19' 8 7/32")	053.3315.600

Guide tracks



		mm (inch)	No.
	Guide track, groove width 7 mm (9/32"), plastic, anthracite	2,500 (8' 2 7/16")	053.3012.250
		3,500 (11' 5 25/32")	053.3012.350
		6,000 (19' 8 7/32")	053.3012.600

Door centering

	No.
Door centering, plastic, anthracite, for 2 doors	053.3207.071

		053.3207.071	No.
Set consisting of:			
	Housing door centering, plastic, anthracite	2	053.5014.001
	Pin door centering, plastic, anthracite	2	053.0171.001
	Rubber buffer, plastic, grey	1	025.0107.001

Accessories

		No.
	Housing Hawa Clipo 15, press-fit, plastic, anthracite	083.3009.001
	Track cleaner, plastic, red	040.3142.071

Further installation examples

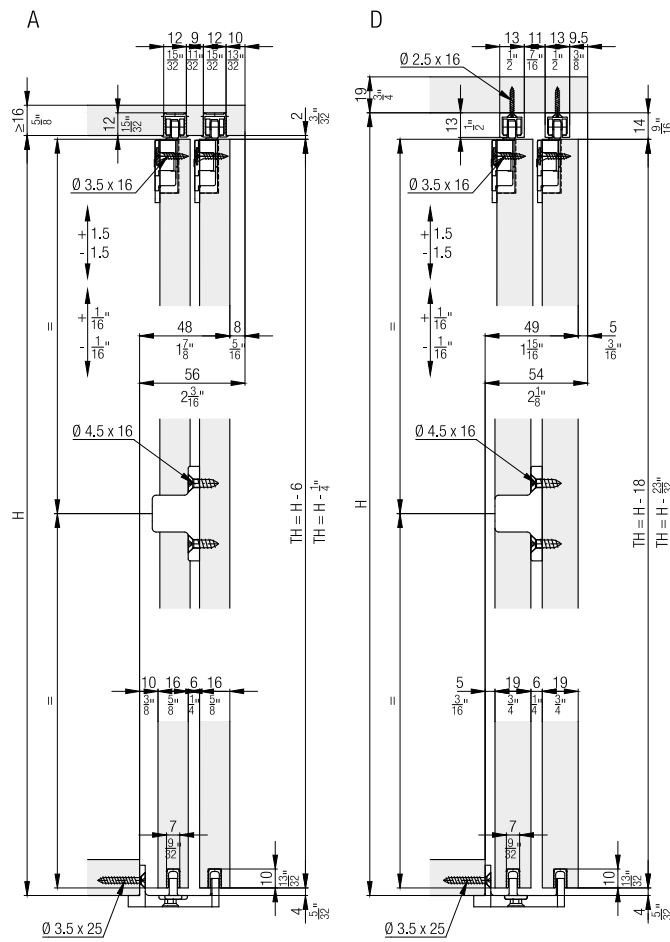

Calculations

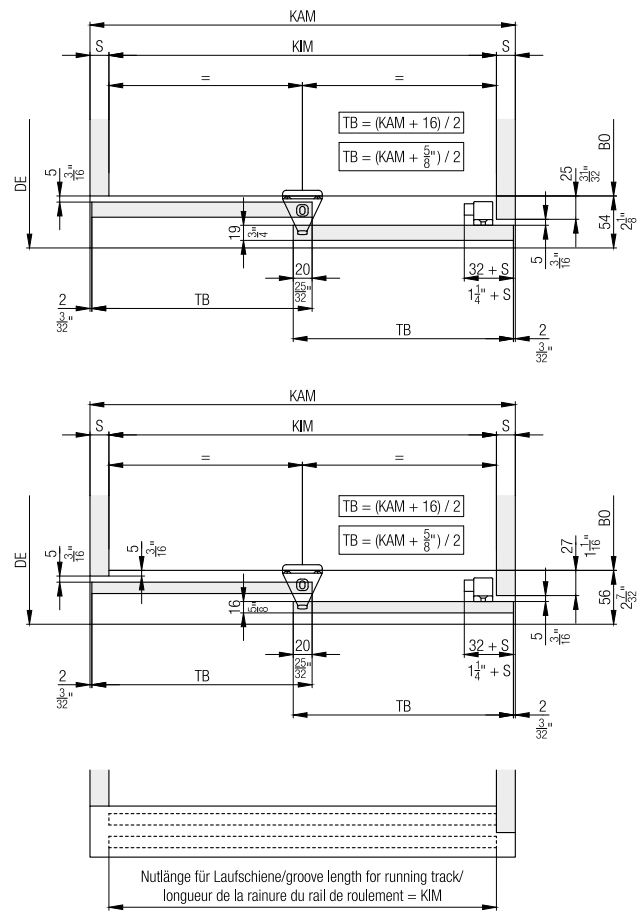

Door centering

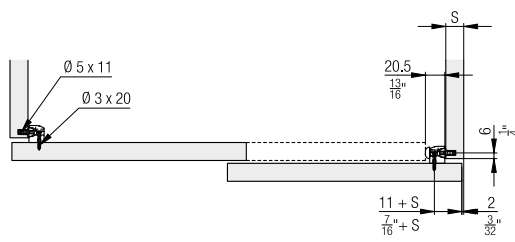

Housing for press-fitting

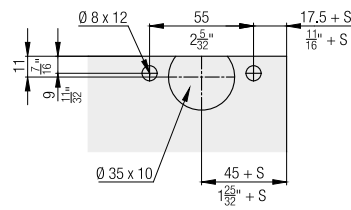

Notched track

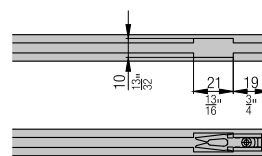

Accessories
 – Straightening fitting from page 236

Planning/execution
 Further information about the product can be found on www.hawa.com.