

Fitting for 1–3 bottom-running L-shaped wooden doors up to 40 kg (88 lbs.). Soft close optional. Design Forslide.

Product highlights

- Comfort** High operating convenience thanks to proven running system and soft closing technology which is integrated in the system
- Aesthetics** L-shaped doors for a unique cabinet design with access to the cabinet interior from two sides

Technical specifications

- Max. 40 kg (88 lbs.)
- Max. 1500 mm (4'11 1/16")
- Max. 1500 mm (4'11 1/16")
- 19 mm (3/4")

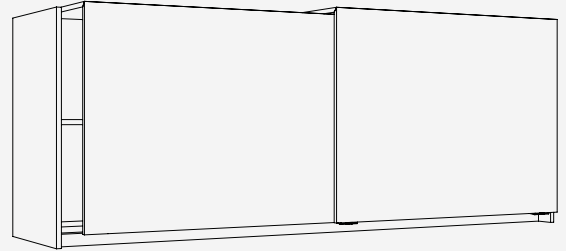

Installation examples

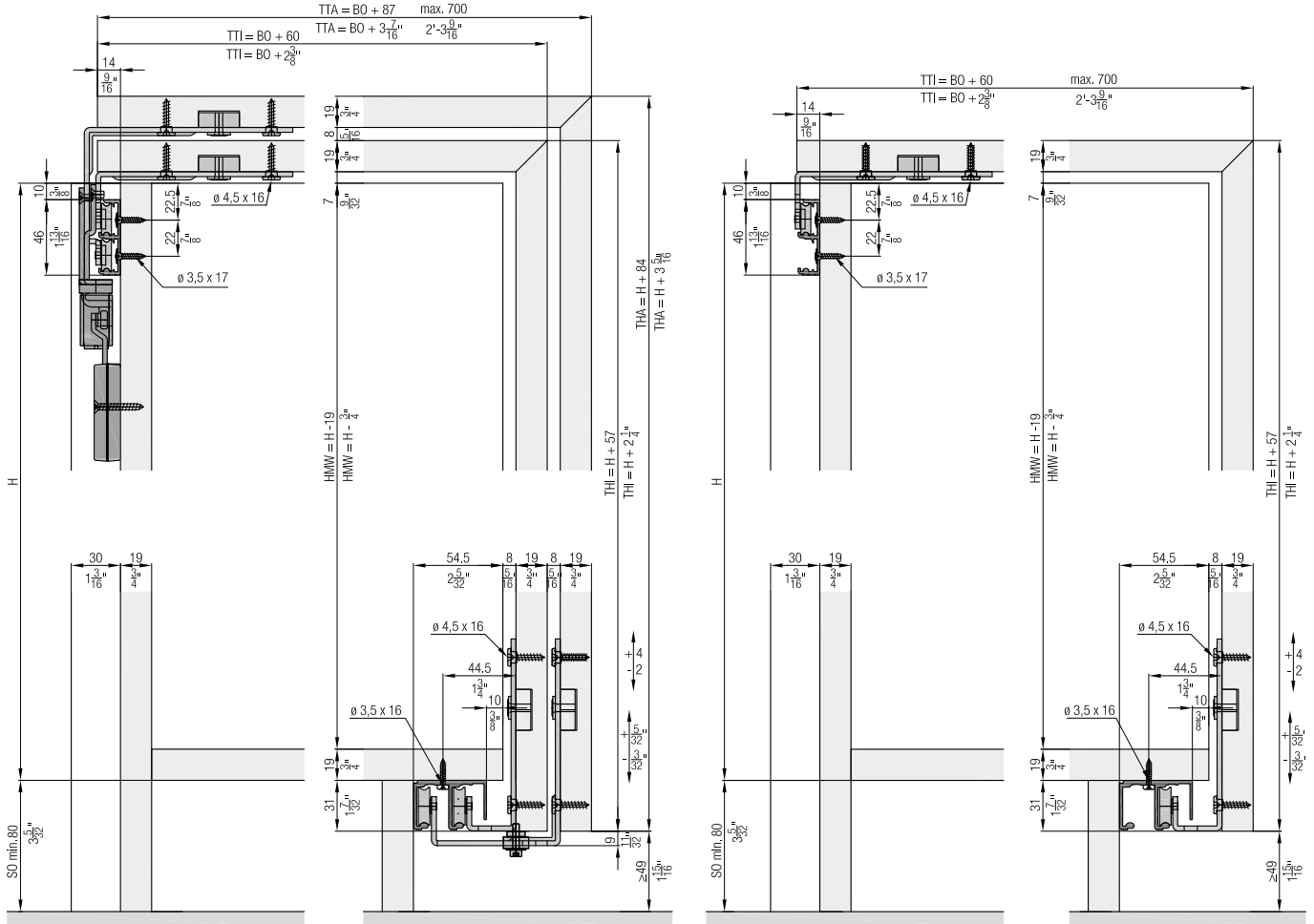

From above

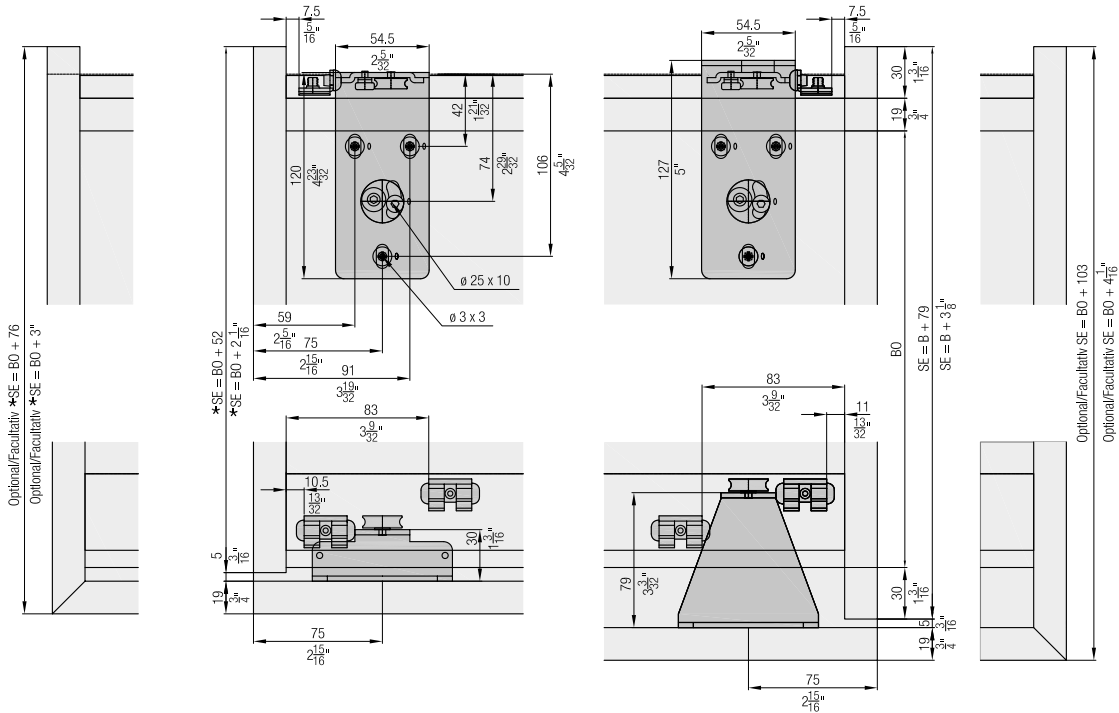



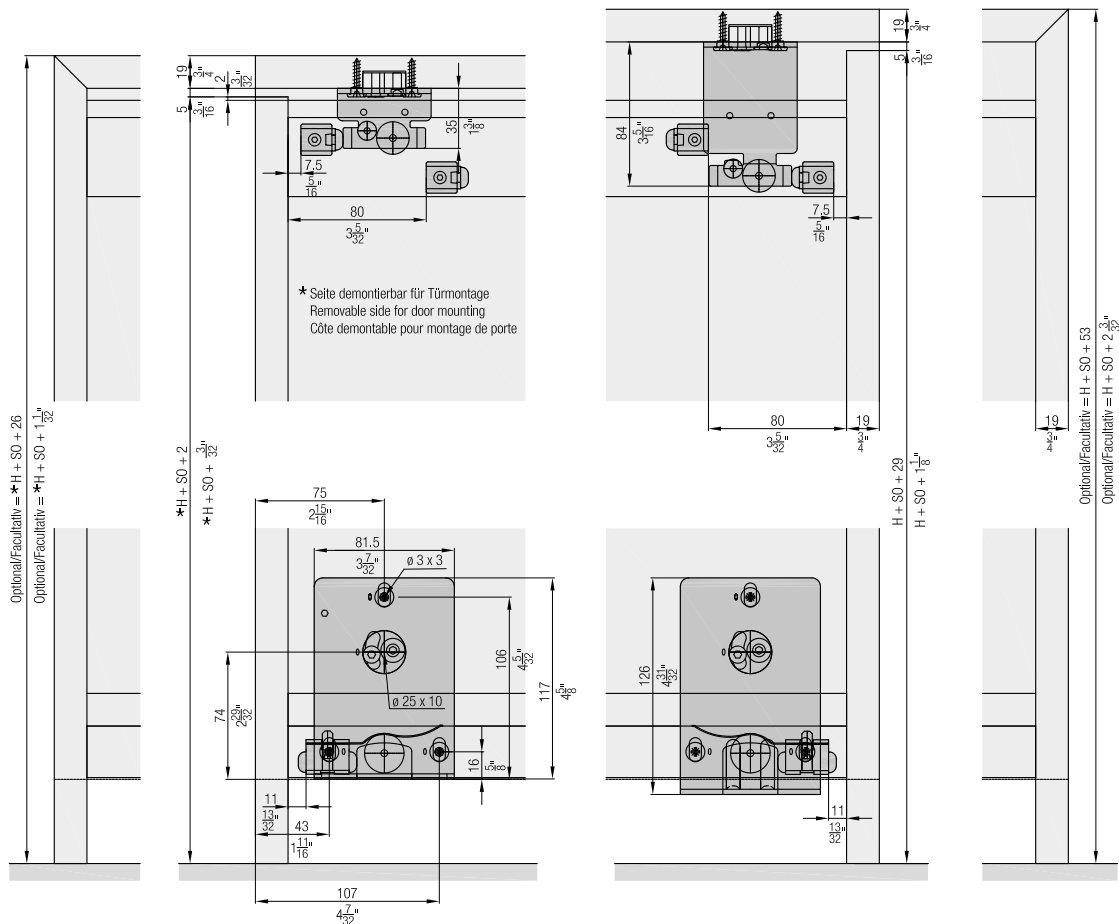





From front

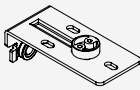

Set for 1 to 3 wooden doors

	No.
Hawa Combino L 40 H FS, for 1 wooden door	056.3160.071
Hawa Combino L 40 H FS, for 2 wooden doors	056.3160.072
Hawa Combino L 40 H FS, for 3 wooden doors	056.3160.073

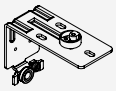
Set consisting of:

		056.3160.071	056.3160.072	056.3160.073	No.
	Running gear, interior door, steel, zinc-plated	2	2	4	056.3155.171
	Guide bracket, interior door, steel, zinc-plated	2	2	4	056.3157.171
	Stopper, plastic, gray	2	4	4	056.3151.071
	Catch spring, steel	2	2	3	056.0174.001
	Stopper, steel, zinc-plated	2	4	4	056.3150.171
	Washer-and-screw assembly, 4.5x17 mm, steel, zinc-plated	12	24	36	055.0100.101
	Wood screw, 3.5x17 mm, steel, zinc-plated	16	16	16	766.6052.100
	Running gear, exterior door, steel, zinc-plated		2	2	056.3154.171
	Guide bracket, exterior door, steel, zinc-plated		2	2	056.3156.171
	Door follower, with 2-3 doors		1	2	056.3162.171
	Rubber buffer, plastic, grey			3	025.0107.001

Running tracks

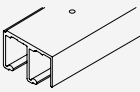
		mm (inch)	No.
	Double running track, aluminum, anodized, pre-drilled	2500 (8'2 7/16")	056.3149.250
		3500 (11'5 25/32")	056.3149.350
		6000 (19'8 7/32")	056.3149.600





Guide tracks

		mm (inch)	No.
	Double guide track, aluminum, anodized, pre-drilled	2500 (8'2 7/16")	056.3148.250
		3500 (11'5 25/32")	056.3148.350
		6000 (19'8 7/32")	056.3148.600

Soft close (only for system with 2 doors)

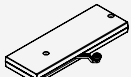
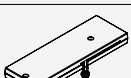
	No.
Soft close, 18–40 kg (40–88 lbs.), with narrow follower, 2 pieces	055.3091.074





Set consisting of:

		055.3091.074	No.
	Soft close, left, 18–40 kg (40–88 lbs.)	1	055.3090.073
	Soft close, right, 18–40 kg (40–88 lbs.)	1	055.3090.074
	Follower, for soft close, right, plastic, gray	1	055.3041.071
	Follower, for soft close, left, plastic, gray	1	055.3041.072
	Fillister head screw, 4x16 mm, steel, zinc-plated	4	600.0000.166
	Countersunk head screw, 4x30 mm, steel, zinc-plated	4	600.0000.439

Adapter soft close

	No.
Adapter set, for soft close	056.3164.071

Set consisting of:

		056.3164.071	No.
	Adapter, for soft close, exterior door, top, steel, zinc-plated	1	056.0179.101
	Adapter, for soft closing system, interior door, top, steel, zinc-plated	1	056.0179.102
	Rounded head screw, M4x8 mm, steel, zinc-plated	4	759.0408.108
	Thread-cutting head screw, M4x8 mm, steel, zinc-plated	4	600.0000.344

Calculation

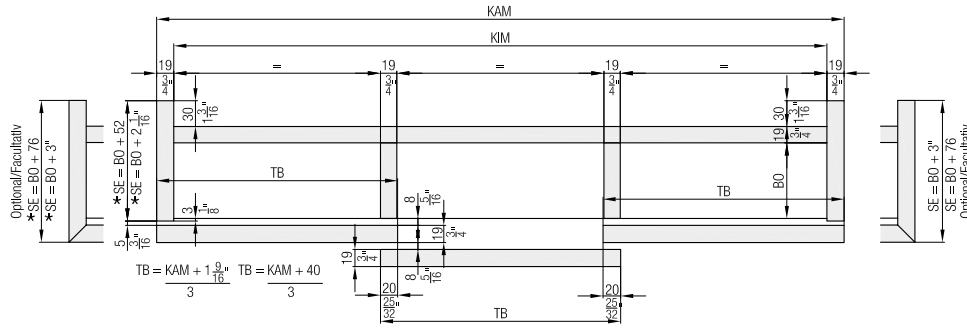

* Seite demontierbar für Türmontage
Removable side for door mounting
Côte démontable pour montage de porte

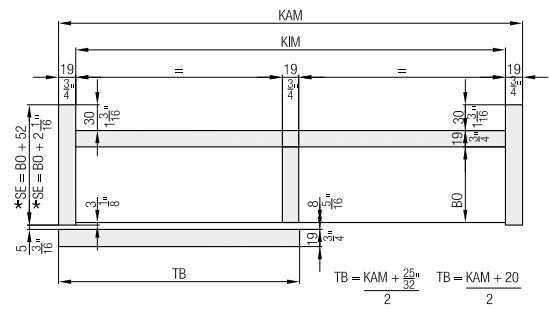
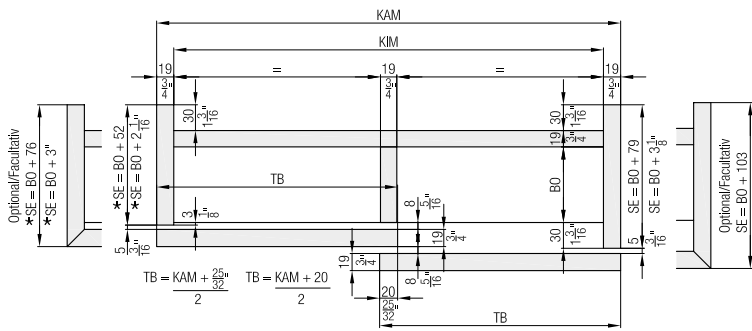

Soft close

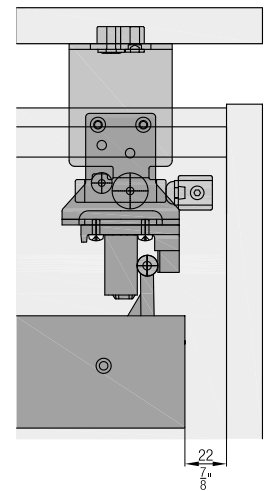
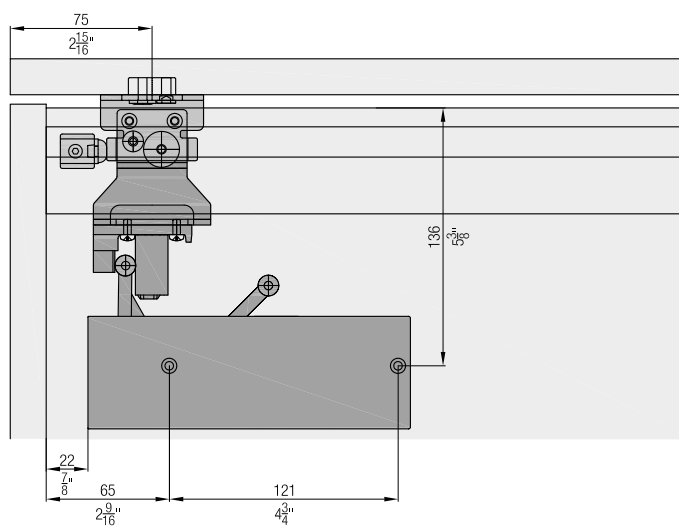
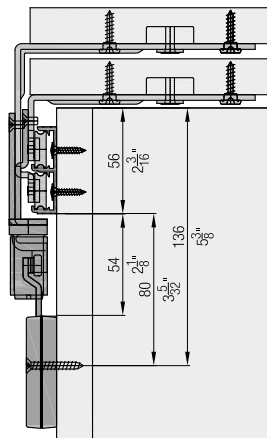

Accessories

- Straightening fitting from page 266
- Order overview soft close from page 270

Planning/execution

Further information about the product can be found on www.hawa.com.