

**Noha**<sup>®</sup>  
the invisible handle

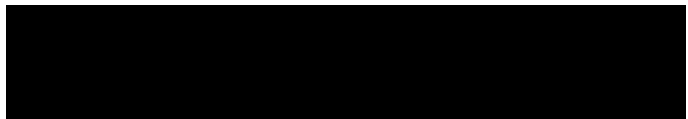

INSTALLATION GUIDE  
NS 200

## START WITH THE MILLING

1

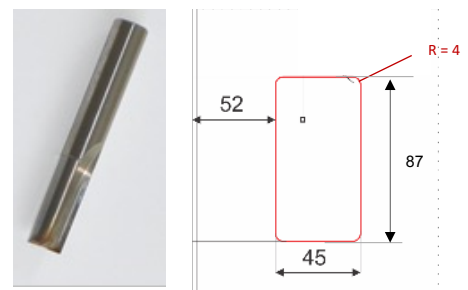

2

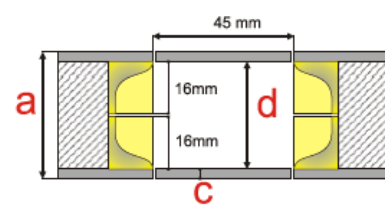
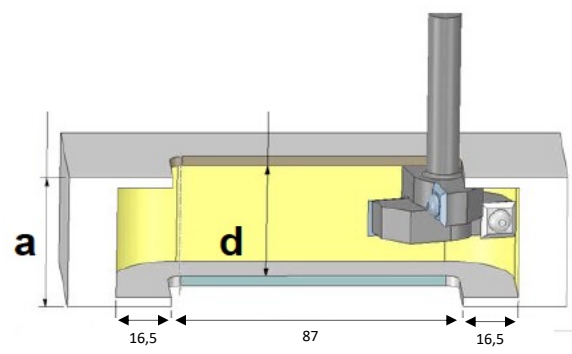
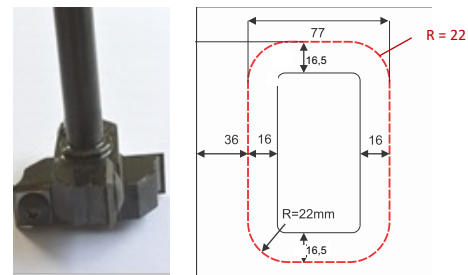

a	d	c
38 mm	32 mm	3 mm
39 mm	33 mm	3 mm
40 mm	33 mm	3.5 mm
41 mm	33 mm	4 mm
42 mm	33 mm	4.5 mm

IMPORTANT: Take care that the dimensions are accurate

# CONTINU WITH THE INSTALLATION

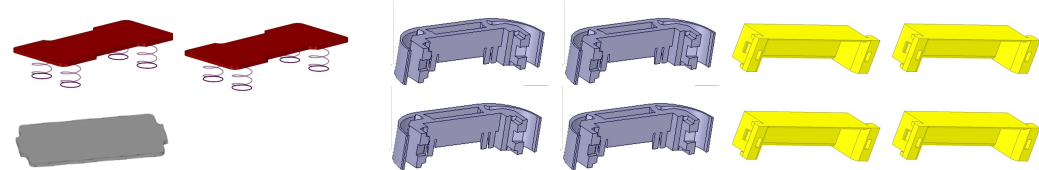

1



2

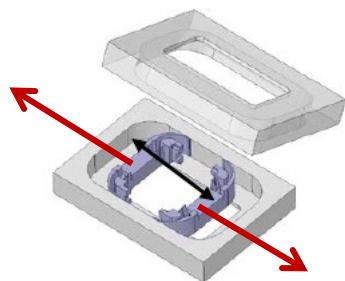

3

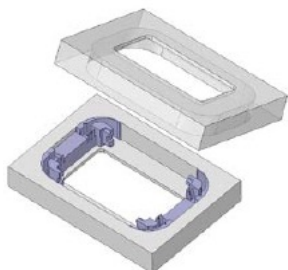

4

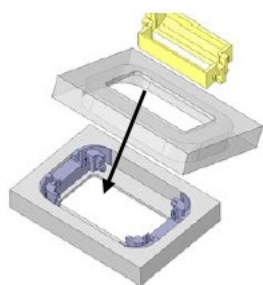

5

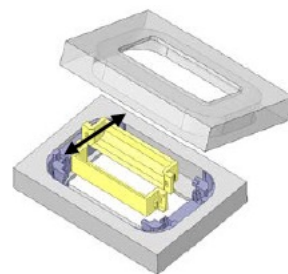

6

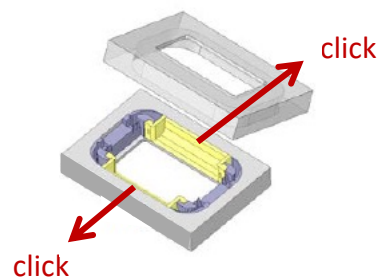

7

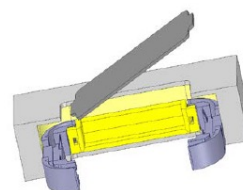

8

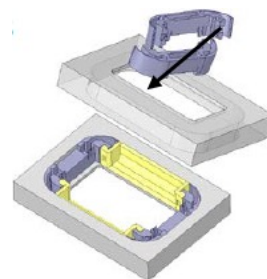

9

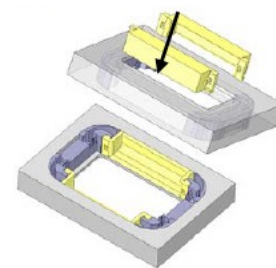

10

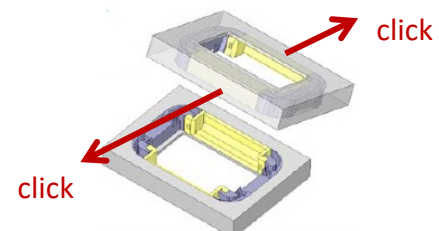

11

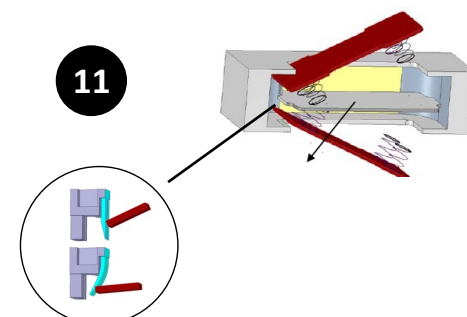

12

