

TOP VIEW

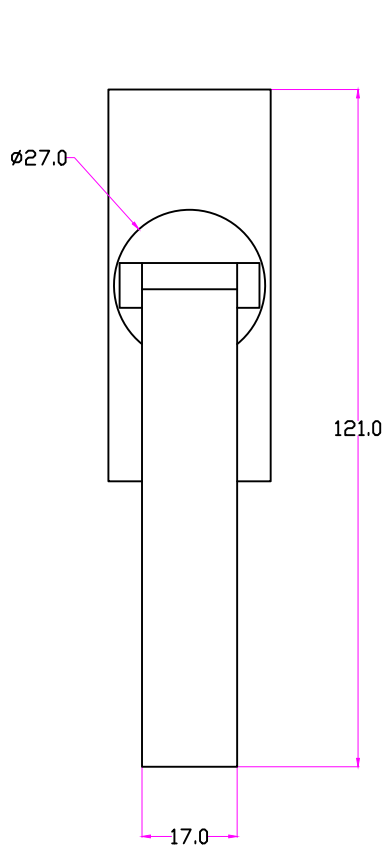

FRONT VIEW

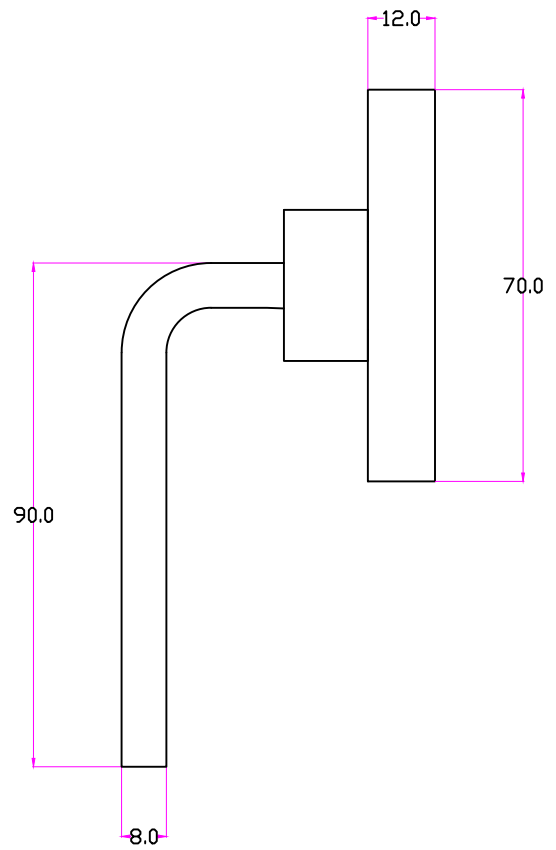

SIDE VIEW

MATERIAL	FINISH	SCALE	DESCRIPTION
BRASS	GA ,AB OS ,BK	NTS	LIV WINDOW HANDLE
PROJN.	UNIT	DATE	ITEM CODE
	MM	22.02.19	J-2190