







Fitting for 2 bottom-running wooden doors up to 20 kg (44 lbs.) with screwed on running track. Soft close optional. Design Forslide.

Product highlights

-  **Comfort** High operating convenience thanks to proven running system and optional soft closing technology
-  **Productivity** No cabinet processing, high degree of pre-assembly and access from the front for easy, quick installation

Technical specifications

-  Max. 20 kg (44 lbs.)
-  Max. 2200 mm (7'2 5/8")
-  Max. 1200 mm (3'11 1/4")
-  19 mm (3/4")

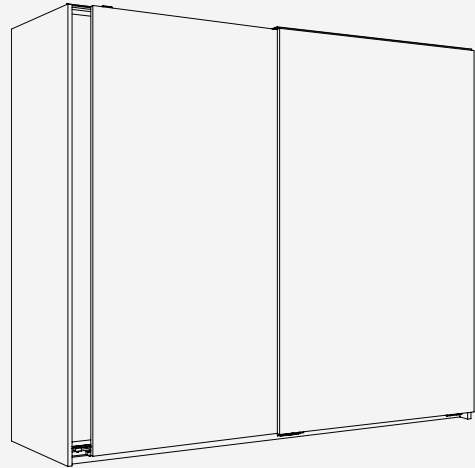



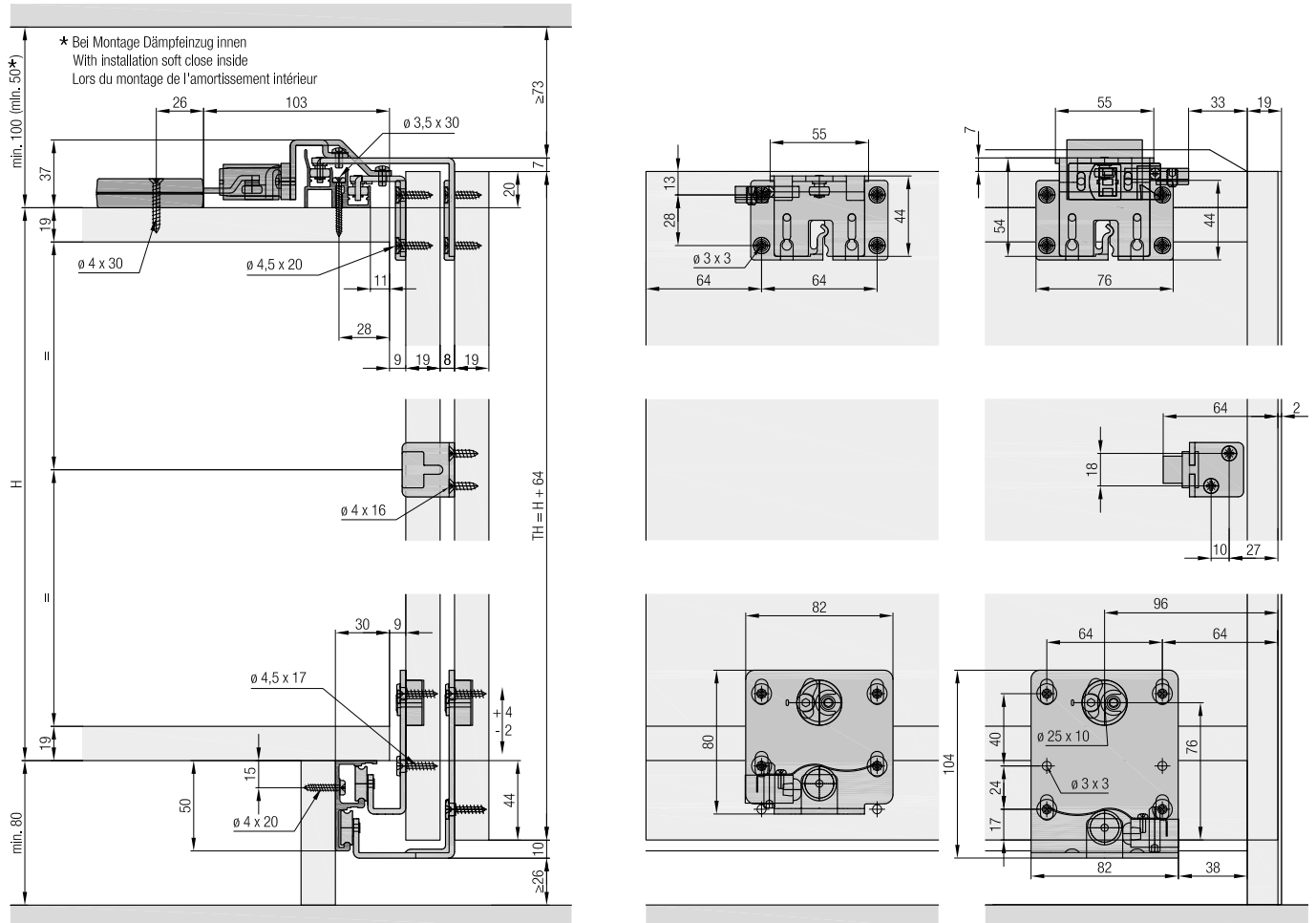



Installation examples



Set for 2 wooden doors

	No.
Hawa Combino 20 H FS, for 2 doors	056.3182.071

Set consisting of:

		056.3182.071	No.
	Running gear, interior door, steel, zinc-plated	2	056.3185.171
	Running gear, exterior door, steel, zinc-plated	2	056.3186.171
	Guide bracket, interior door, steel, zinc-plated	2	055.3107.171
	Guide bracket, exterior door, steel, zinc-plated	2	055.3108.171
	Guide bracket housing, plastic, anthracite	4	053.3064.001
	Stopper, plastic, gray	2	056.3189.071
	Stopper, with retention spring, plastic, gray	2	056.3189.072
	Stopper guide, plastic, gray	4	040.3079.074
	Door follower, with 2 doors, steel, zinc-plated	1	055.3124.071
	Washer-and-screw assembly, 4.5x17 mm, steel, zinc-plated	16	055.0100.101
	Countersunk head screw, 4.5x20 mm, steel, zinc-plated	16	600.0000.167

Running tracks

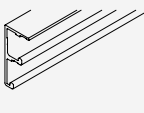
		mm (inch)	No.
	Double running track, aluminum, anodized, pre-drilled	2500 (8'2 7/16")	056.3184.250
		3500 (11'5 25/32")	056.3184.350
		6000 (19'8 7/32")	056.3184.600

Guide tracks

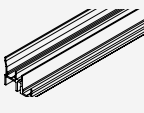
		mm (inch)	No.
	Double guide track, aluminum, anodized, pre-drilled	2500 (8'2 7/16")	056.3072.250
		3500 (11'5 25/32")	056.3072.350
		6000 (19'8 7/32")	056.3072.600



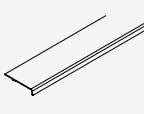

Panels

		mm (inch)	No.
	Cover panel, aluminum, anodized	2500 (8'2 7/16")	055.3130.250
		3500 (11'5 25/32")	055.3130.350
		6000 (19'8 7/32")	055.3130.600

Soft close (installation outside)

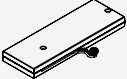
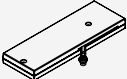
	No.
Soft close, up to 18 kg (40 lbs.), with narrow follower, 2 pieces	055.3091.072
Soft close, 18-40 kg (40-88 lbs.), with narrow follower, 2 pieces	055.3091.074



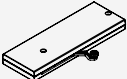
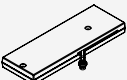

Set consisting of:

		055.3091.072	055.3091.074	No.
	Soft close, left, up to 18 kg (40 lbs.)	1		055.3090.071
	Soft close, right, up to 18 kg (40 lbs.)	1		055.3090.072
	Follower, for soft close, right, plastic, gray	1	1	055.3041.071
	Follower, for soft close, left, plastic, gray	1	1	055.3041.072
	Fillister head screw, 4x16 mm, steel, zinc-plated	4	4	600.0000.166
	Countersunk head screw, 4x30 mm, steel, zinc-plated	4	4	600.0000.439
	Soft close, left, 18-40 kg (40-88 lbs.)		1	055.3090.073
	Soft close, right, 18-40 kg (40-88 lbs.)		1	055.3090.074

Adapter soft close (installation outside) for No. 055.3091.072 and 055.3091.074





	No.
Adapter set, for soft close	055.3129.071

Set consisting of:

		055.3129.071	No.
	Adapter, for soft close, interior door, top, steel, zinc-plated	1	055.0211.101
	Adapter, for soft close, exterior door, top, steel, zinc-plated	1	055.0212.101
	Rounded head screw, M4x8 mm, steel, zinc-plated	4	759.0408.108
	Thread-cutting rounded head screw, M4x8 mm, steel, zinc-plated	4	600.0000.328

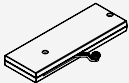
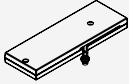
Soft close (installation inside)

	No.
Soft close, up to 18 kg (40 lbs.), with wide follower, 2 pieces	055.3091.071
Soft close, 18–40 kg (40–88 lbs.), with wide follower, 2 pieces	055.3091.073

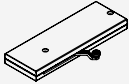
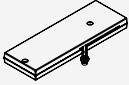
Set consisting of:	055.3091.071		055.3091.073		No.
 Soft close, left, up to 18 kg (40 lbs.)	1				055.3090.071
 Soft close, right, up to 18 kg (40 lbs.)	1				055.3090.072
 Follower, for soft close, right, plastic, gray	1	1			055.3040.071
 Follower, for soft close, left, plastic, gray	1	1			055.3040.072
 Fillister head screw, 4x16 mm, steel, zinc-plated	6	6			600.0000.166
 Countersunk head screw, 4x30 mm, steel, zinc-plated	4	4			600.0000.439
 Soft close, left, 18–40 kg (40–88 lbs.)			1		055.3090.073
 Soft close, right, 18–40 kg (40–88 lbs.)			1		055.3090.074

Calculations

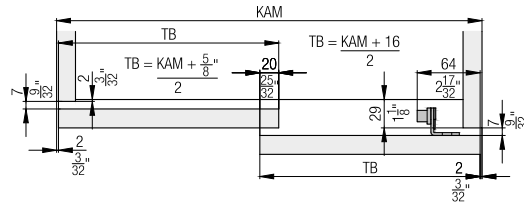

Optional: Guide track installation from below

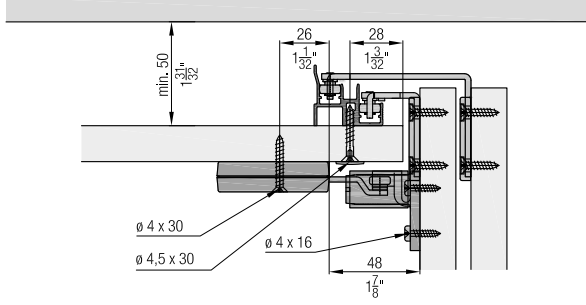

Handle profiles

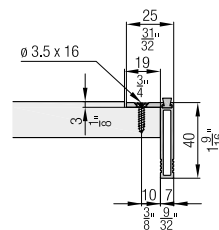

Soft close (installation inside)

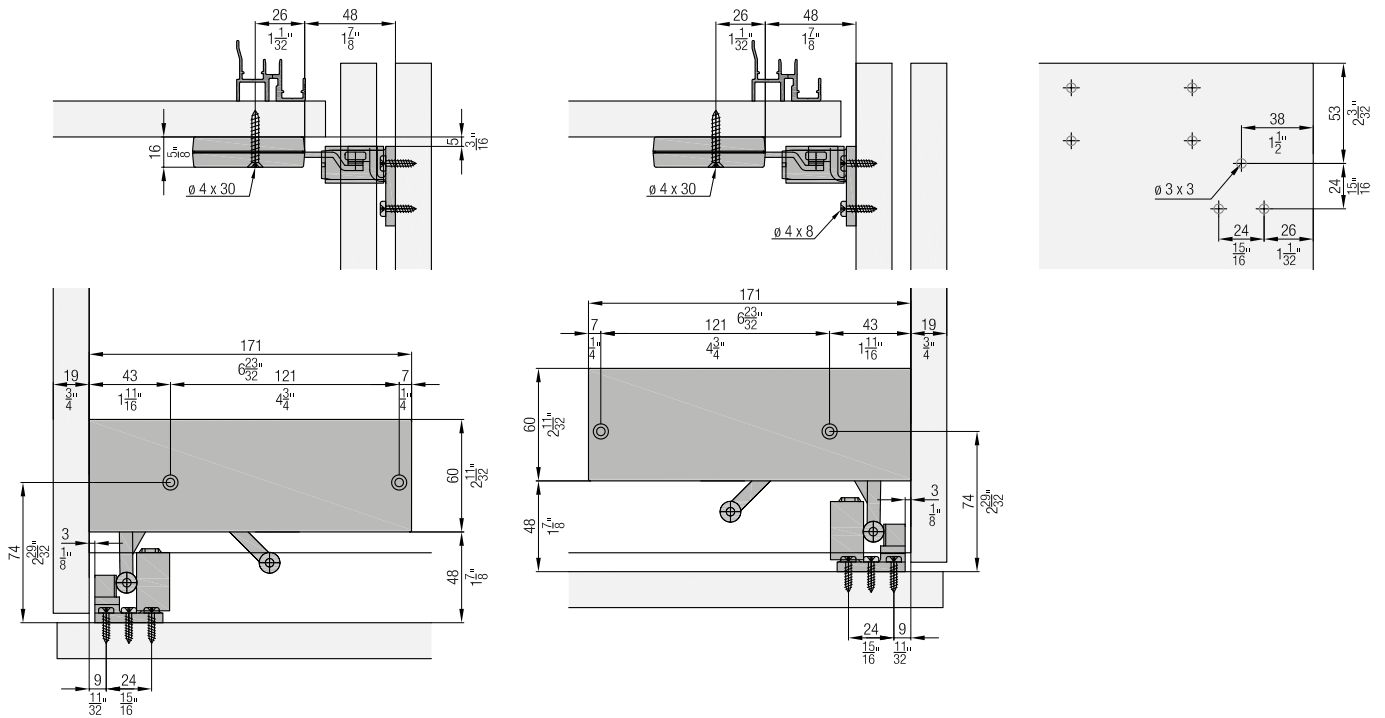

Soft close (installation outside)

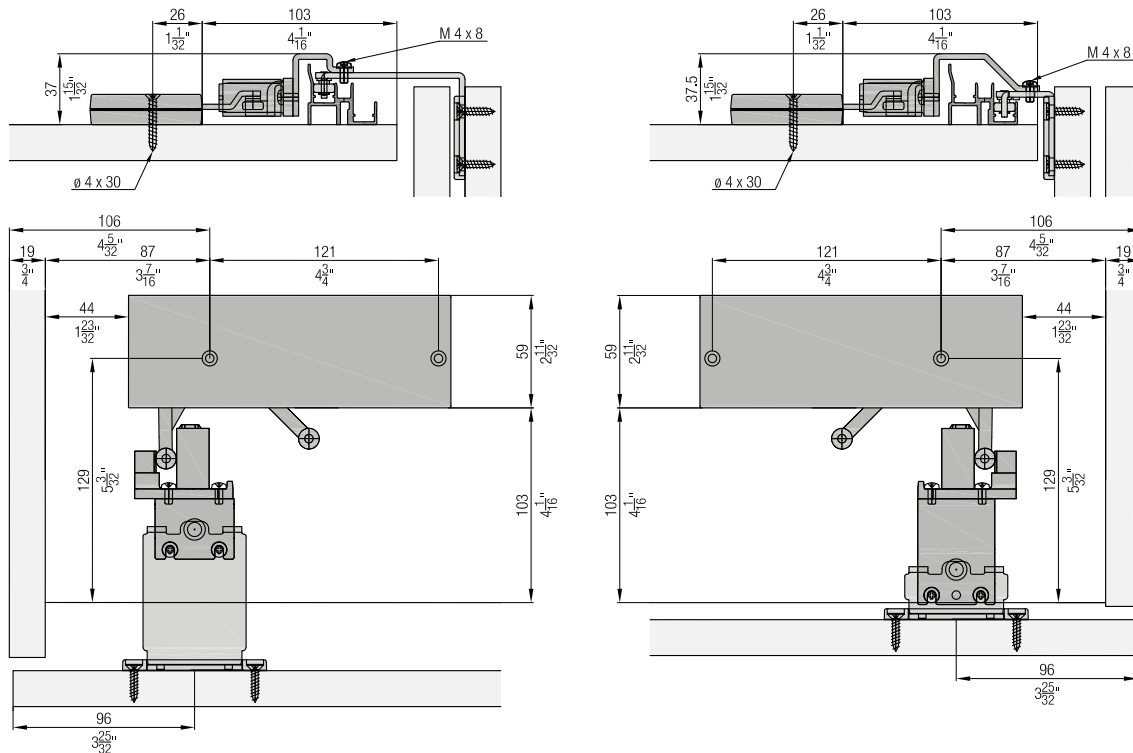

Accessories

- Straightening fitting from page 266
- Handle profiles from page 268
- Order overview soft close from page 270

Planning/execution

Further information about the product can be found on www.hawa.com.