

Fitting for 2-3 bottom-running wooden doors up to 80 kg (176 lbs.), with screwed on running track and wooden clip panel. Optional soft close integrated in track. Design Forslide bottom-running.

Product highlights



Comfort

Sophisticated soft close also for center doors and an innovative arrangement of the components make for very easy operation



Aesthetics

Bottom-running system that supports the entire door weight on the base makes cabinet designs with thin materials possible

Technical specifications



Max. 80 kg (176 lbs.)



Max. 2800 mm (9'2 1/4")



Max. 1600 mm (5'3")



25/40 mm (31/32" or 1 9/16")

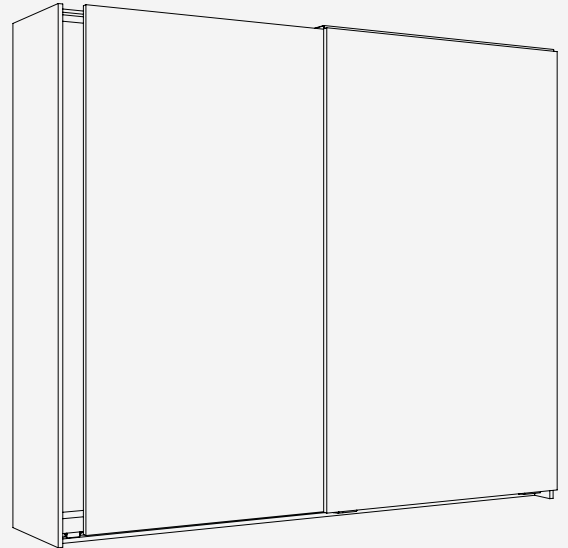



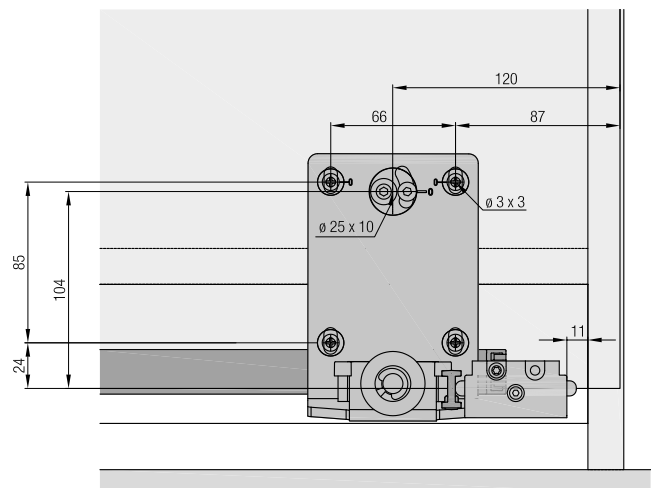
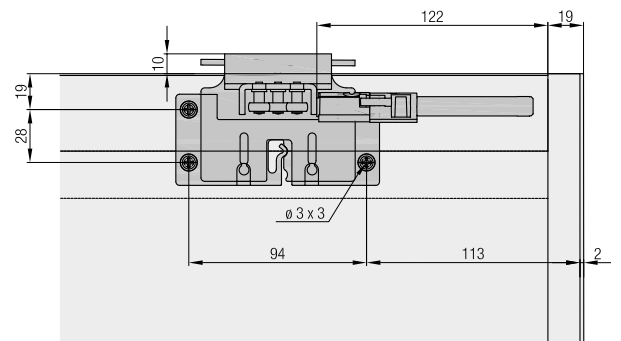
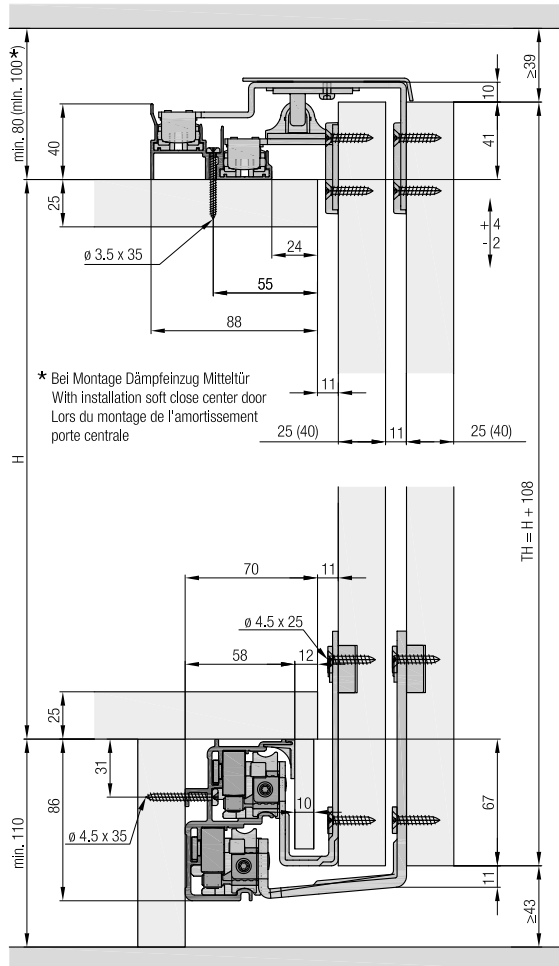









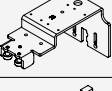

Installation examples



Set for 2 or 3 wooden doors, 25 mm (31/32")

	No.
Hawa Combino 80 H FS ul, door thickness 25 mm (31/32"), for 2 doors	055.3201.072
Hawa Combino 80 H FS ul, door thickness 25 mm (31/32"), max. door width 1350 mm (4'5 5/32"), for 3 doors	055.3201.074

Set consisting of:

		055.3201.072	055.3201.074	No.
	Running gear, interior door, steel, zinc-plated	2	4	055.3147.071
	Running gear, exterior door, 25 mm (31/32"), steel, matt nickel-plated	2	2	055.3146.072
	Guide bracket, interior door, steel, zinc-plated	2	4	055.3136.071
	Guide bracket, exterior door, 25 mm (31/32"), steel, zinc-plated	2	2	055.3137.071
	Guide bracket housing, plastic, anthracite	4	6	055.0237.001
	Stopper, plastic, gray	4	4	055.3145.071
	Retention spring for stopper, plastic, gray	2	3	055.0267.001
	Stopper guide, plastic, gray	4	4	055.3135.071
	Door follower, with soft close, plastic, gray	1	2	055.0268.001
	Activator, for door follower, steel, zinc-plated	1	2	055.0238.101
	Panel clip, plastic, gray	10	15	055.3071.001
	Centering disk, plastic, white	16	24	055.0110.001
	Countersunk head screw, 4.5x25 mm, steel, zinc-plated	32	48	766.5045.125
	Countersunk head screw, 3x10 mm, steel, zinc-plated	10	15	600.0000.395
	Thread-cutting rounded head screw, M4x6 mm, steel, zinc-plated	1	2	762.7009.107
	Thread-cutting countersunk head screw, M3x6 mm, steel, zinc-plated	2	4	600.0000.789
	Buffer, with adhesive, 2-piece set		1	053.3364.051

Set for 2 or 3 wooden doors, 40 mm (1 9/16")

	No.
Hawa Combino 80 H FS ul, door thickness 40 mm (1 9/16"), for 2 doors	055.3201.071
Hawa Combino 80 H FS ul, door thickness 40 mm (1 9/16"), max. door width 1350 mm (4'5 5/32"), for 3 doors	055.3201.073

Set consisting of:

		055.3201.071	055.3201.073	No.
	Running gear, interior door, steel, zinc-plated	2	4	055.3147.071
	Running gear, exterior door, 40 mm (1 9/16"), steel, matt nickel-plated	2	2	055.3146.074
	Guide bracket, interior door, steel, zinc-plated	2	4	055.3136.071
	Guide bracket, exterior door, 40 mm (1 9/16"), steel, zinc-plated	2	2	055.3137.073
	Guide bracket housing, plastic, anthracite	4	6	055.0237.001
	Stopper, plastic, gray	4	4	055.3145.071
	Retention spring for stopper, plastic, gray	2	3	055.0267.001
	Stopper guide, plastic, gray	4	4	055.3135.071
	Door follower, with soft close, plastic, gray	1	2	055.0268.001
	Activator, for door follower, steel, zinc-plated	1	2	055.0238.101
	Panel clip, plastic, gray	10	15	055.3071.001
	Centering disk, plastic, white	16	24	055.0110.001
	Countersunk head screw, 4.5x25 mm, steel, zinc-plated	32	48	766.5045.125
	Countersunk head screw, 3x10 mm, steel, zinc-plated	10	15	600.0000.395
	Thread-cutting rounded head screw, M4x6 mm, steel, zinc-plated	1	2	762.7009.107
	Thread-cutting countersunk head screw, M3x6 mm, steel, zinc-plated	2	4	600.0000.789
	Buffer, with adhesive, 2-piece set		1	053.3364.051



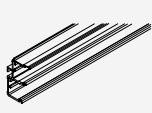
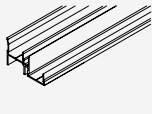
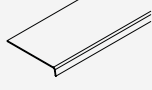
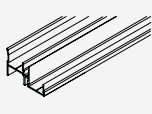

Track sets

	No.
Hawa Combino 65/80 H FS ul, 2500 mm (8'2 7/16")	055.3210.071
EKU Combino 65/80 H FS ul, 4000 mm (13'1 15/32")	055.3210.072

	mm (inch)	055.3210.071	055.3210.072	No.
Set consisting of:				
 Double running track, aluminum, anodized, pre-drilled	2500 (8'2 7/16")	1		055.3142.250
 Double guide track, aluminum, anodized, pre-drilled	2500 (8'2 7/16")	1		055.3134.250
 Panel profile cover, aluminum, anodized	1300 (4'3 3/16")	1		055.3170.130
 Double running track, aluminum, anodized, pre-drilled	4000 (13'1 15/32")		1	055.3142.400
 Double guide track, aluminum, anodized, pre-drilled	4000 (13'1 15/32")		1	055.3134.400
 Panel profile cover, aluminum, anodized	1600 (5'3")		1	055.3170.160



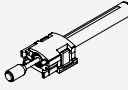



Soft close

	No.
Hawa Combino 80 FS ul, 65–80 kg (143-176 lbs.), 4 pieces	055.3213.071

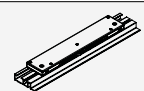
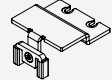
	055.3213.071	No.
Set consisting of:		
 Soft close, right, up to 80 kg (176 lbs.)	2	055.3138.071
 Soft close, left, up to 80 kg (176 lbs.)	2	055.3138.072
 Activator, for soft close	4	055.3157.071
 Soft close for guide (recommended from a door ratio bigger than 1:3. Can only be used with a soft close.)	4	055.3148.071
 Thread-cutting rounded head screw, M5x16 mm, steel, zinc-plated	4	600.0000.591
 Thread-cutting countersunk head screw, M5x10 mm, steel, zinc-plated	4	600.0000.345

Soft close center door

	No.
Hawa Combino 65/80 H FS, center door	055.3217.071

	055.3217.071	No.
Set consisting of:		
 Soft close, center door	1	055.3193.071
 Activator, for soft close center door	1	055.3196.071
 Safety device for guide bracket, plastic, anthracite	1	053.3099.001
 Rubber buffer, plastic, transparent	2	055.0318.001
 Thread-cutting rounded head screw, M4x8 mm, steel, zinc-plated	2	762.7009.100
 Fillister head screw, 4x16 mm, steel, zinc-plated	2	600.0000.166
 Countersunk head screw, 4.5x20 mm, steel, zinc-plated	1	600.0000.167

Soft close

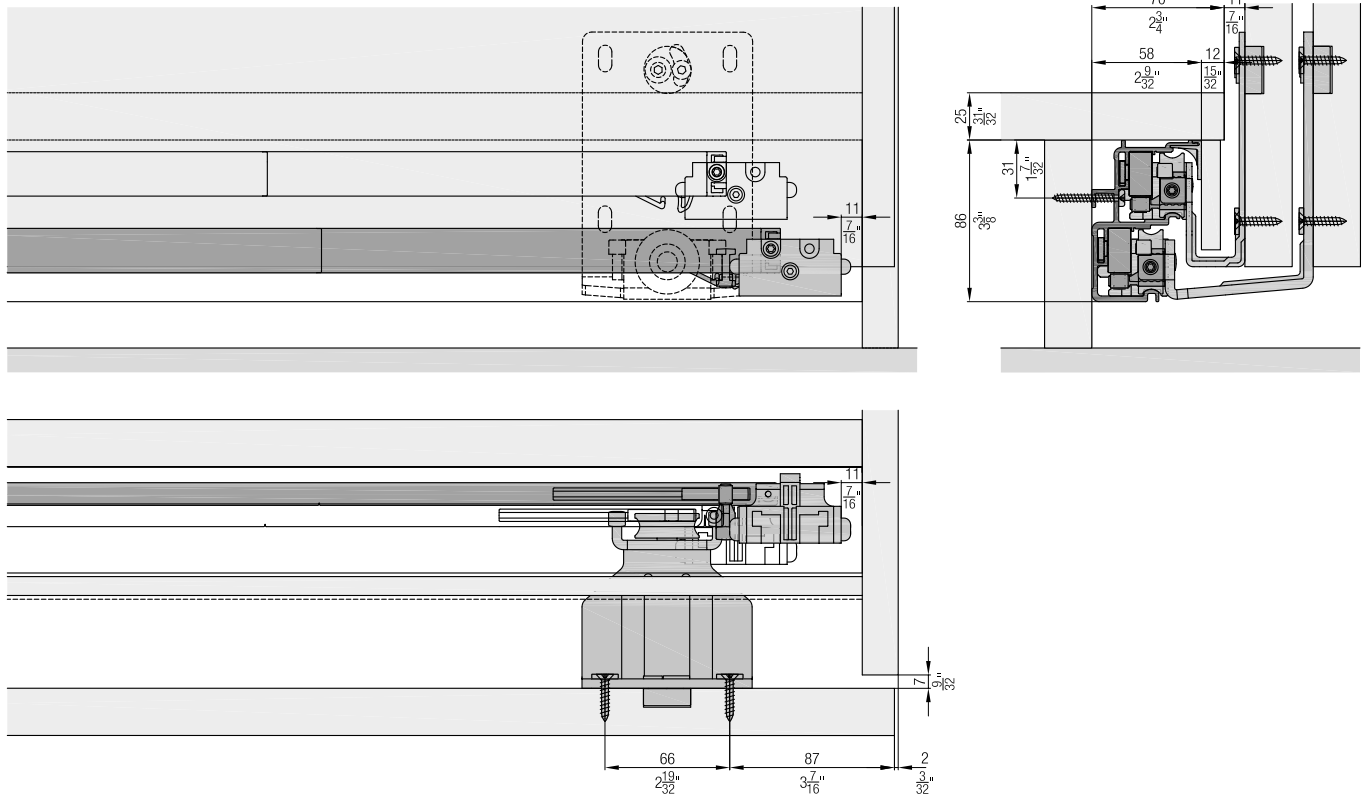

Soft close center door

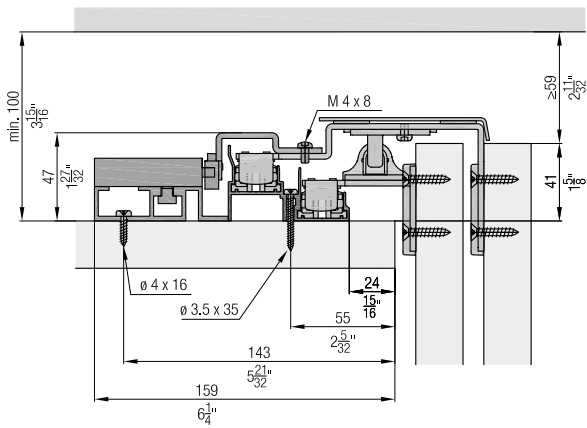

Accessories

- Straightening fitting from page 266
- Handle profiles from page 268
- Order overview soft close from page 270

Planning/execution

Further information about the product can be found on www.hawa.com.