

Fitting for top-running glass doors up to 120 kg (264 lbs.), with surface mounted running track or running track flush with the ceiling. Optionally with soft and self closing mechanism. Wall or ceiling mounting.

Product highlights

- Aesthetics** Neutral, linear design
- Security** Very safe thanks to positive-fit glass fixing

Technical specifications

- Max. 120 kg (264 lbs.)
- Max. 4000 mm (13'1 15/32")
- Max. 3000 mm (9'10 1/8")
- 8-16 mm (5/16" to 5/8")

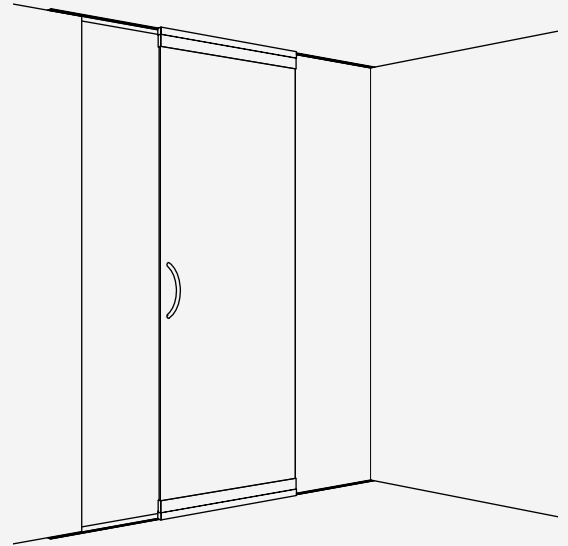



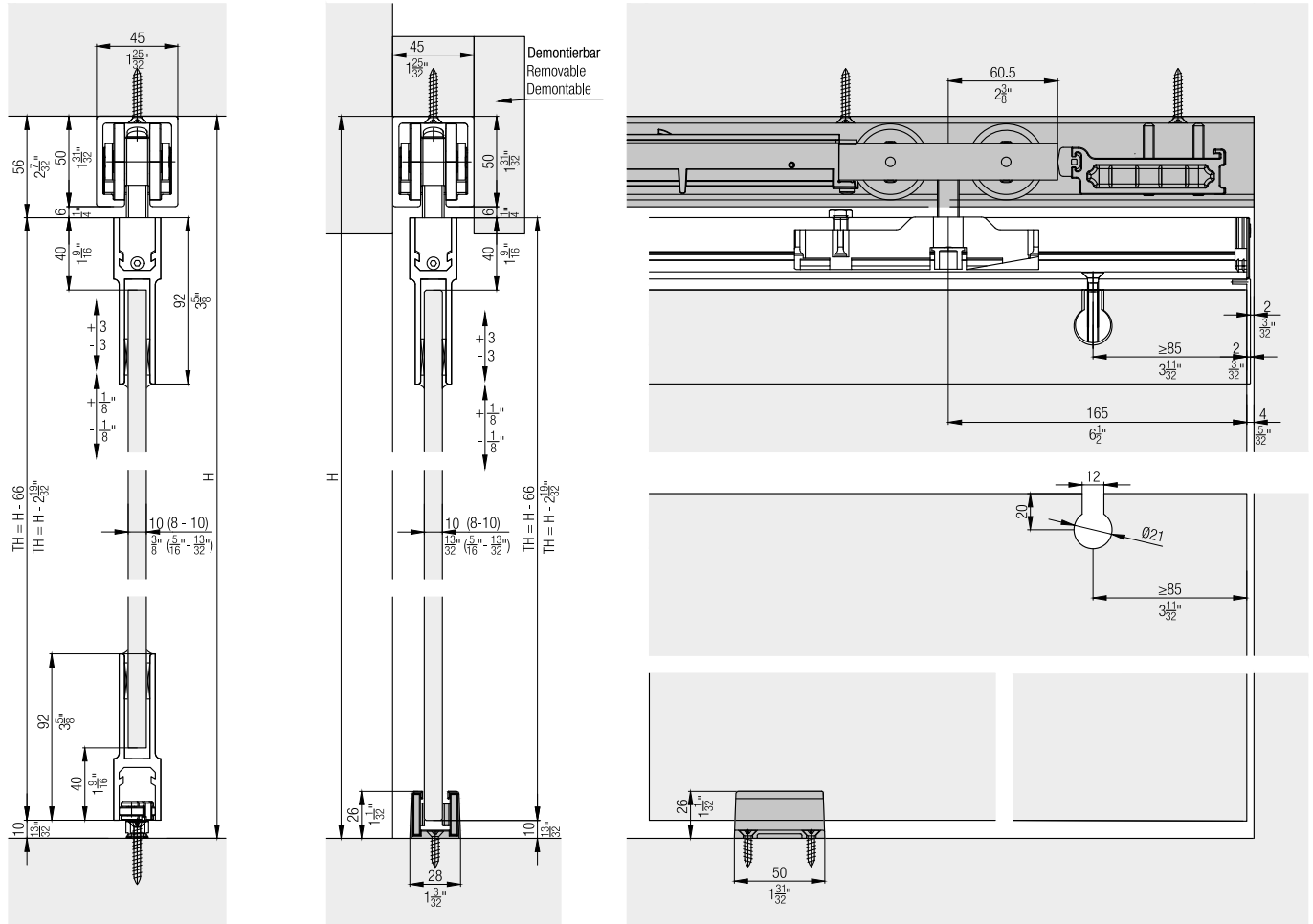

Installation examples



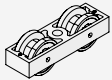
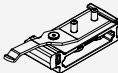
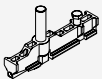

Set for 1 glass door up to 120 kg (264 lbs.)

	No.
Hawa Junior 120 G, for 1 door	25910



Set consisting of:

		25910	No.
	Two-wheeled running gear, M12, plastic wheels	2	25900
	Track stopper, with adjustable retention spring	2	14858
	Suspension plate, with suspension bolt M12	2	15294
	Screw-on rubber door stop	1	10629
	Cover cap for glass suspension profile, plastic, anthracite	2	20907
	Suspension assembly locking wrench	1	14861

Suspension and glass retaining profiles

		mm (inch)	No.
	Glass suspension/retainer profile, aluminum, anodized, brushed, glass up to 8–16 mm (5/16"–5/8")	6,500 (21' 3 29/32")	21783
		cut to size	21784
	Glass suspension/retainer profile, aluminum, glass up to 16 mm (5/8")	6,500 (21' 3 29/32")	13158
	Glass suspension/retainer profile, aluminum, glass up to 16 mm (5/18")	cut to size	13159
	Glass suspension/retainer profile, aluminum, anodized, brushed, glass up to 8–10 mm (5/16"–13/32")	6,500 (21' 3 29/32")	21781
		cut to size	21782
	Glass suspension/retainer profile, aluminum, glass up to 10 mm (13/32")	6,500 (21' 3 29/32")	10348
		cut to size	10349
	Multi purpose suspension and retainer profile, aluminum, anodized, undrilled	6,500 (21' 3 29/32")	10345
		cut to size	12915

Cover caps







		No.
	Cover cap for glass suspension/retainer profile 21783/21784/13158/13159, glass up to 16 mm (5/8"), plastic, anthracite	21085
	Cover cap for glass suspension/retainer profile 21781/21782/10348/10349, glass up to 10 mm (13/32"), plastic, anthracite	21512

Glass holder

Order 2 pieces per suspension and glass retaining profile

		No.
	Glass holder insert, plastic, with countersunk head screw, M6x30 mm (1/4"x1 3/16")	10792

Bottom guides

		No.
	Guide, rattle proof, with suspension block, plastic, 14 mm (9/16")	13781
	Bottom guide, rattle proof, with self-adhesive sliders for satinised glass, glass thickness 8–12.7 mm (5/16"–1/2"), chrome-plated, matt	16029
	Bottom guide, rattle proof, with self-adhesive sliders for satinised glass, glass thickness 8–12.7 mm (5/16"–1/2"), stainless steel look	21267
	Rattle-proof mounted guide, with wheels	24905
	Distance plate to bottom guide	16657
	Connecting bolt for bottom guide track, 6x40 mm (1/4"x1 9/16"), steel, zinc-plated	13759

Running tracks

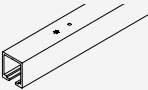
		mm (inch)	No.
	Running track, aluminum, anodized, pre-drilled	2,500 (8' 2 7/16")	14866
		3,000 (9' 10 1/8 ")	14867
		4,000 (13' 1 15/32")	14868
		6,000 (19' 8 7/32")	14869
		cut to size	14871

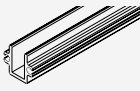

Guide tracks

		mm (inch)	No.
	Guide track, aluminum, anodized, pre-drilled	6,000 (19' 8 7/32")	13688
		cut to size	13690

Running track set with fixed glazing, 3000 mm (9'10 1/8"), aluminum, anodized

		No.
Set running tracks, with fixed glass, aluminum, anodized, pre-drilled		20229



Set consisting of:

		20229	No.
	Set running tracks, with fixed glass, aluminum, anodized, pre-drilled	1	20235
	Cover profile to running track with fixed glass, aluminum, anodized	1	19553

Running track set with fixed glazing, 4000 mm (13'1 7/16"), aluminum, anodized

		No.
Set running tracks, with fixed glass, aluminum, anodized, pre-drilled		20230



Set consisting of:

		20230	No.
	Running track with fixed glass, aluminum, anodized, pre-drilled	1	20054
	Cover profile to running track with fixed glass, aluminum, anodized	1	19553

Running track set with fixed glazing, 6000 mm (19'8 7/32"), aluminum, anodized

		No.
Set running tracks, with fixed glass, aluminum, anodized, pre-drilled		20231

Set consisting of:

		20231	No.
	Running track with fixed glass, aluminum, anodized, pre-drilled	1	20055
	Cover profile to running track with fixed glass, aluminum, anodized	1	19562

Soft close SoftMove 120

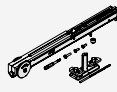

**For soft closing in opening and closing direction
order 2 sets.**

		No.
	Soft close SoftMove 120	25988

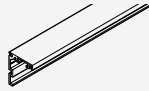
Angled profiles for wall mounting



		mm (inch)	No.
	Angled profile for wall mounting, aluminum, anodized, pre-drilled	4,000 (13' 1 15/32")	25327
		6,000 (19' 8 7/32")	25328
		cut to size	25329

Individual components to angled profile

		No.
	Set for wall mounting, track length up to 2000 mm (6' 6 3/4 "), 10-piece set	19041
	Cover cap to angled profile, metal, chrome-plated, matt, suitable to both sides	25335
	Connecting pins to profiles, 2-piece set	21347

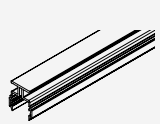
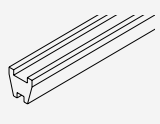
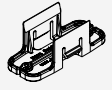

Hawa Adapto 120 concrete casting system, without fixed glazing

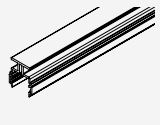
		No.
Inset profile for concrete surfaces Hawa Adapto 120, without fixed glass, 3000 mm (9'10 1/8")		20218
Inset profile for concrete surfaces Hawa Adapto 120, without fixed glass, 4000 mm (13'1 15/32")		20219

		mm (inch)	20218	20219	No.
Set consisting of:					
	Inset profile for concrete surfaces, without fixed glass, aluminum	3,000 (9' 10 1/8 ")	1		20093
	Polystyrene insert, 1000 mm (3'3 1/4 "), without fixed glass	1,000 (3' 3 3/8 ")	3	4	19419
	Assembly clips, plastic, black, without fixed glass		4	5	19346
	Cover cap, without fixed glass, plastic, gray		2	2	19368
	Inset profile for concrete surfaces, without fixed glass, aluminum	4,000 (13' 1 15/32")		1	20091



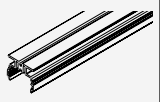
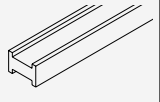
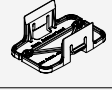

Hawa Adapto 120 concrete casting system, with fixed glazing

		No.
Inset profile for concrete surfaces Hawa Adapto 120, with fixed glass, 3000 mm (9'10 1/8")		20222
Inset profile for concrete surfaces Hawa Adapto 120, with fixed glass, 4000 mm (13'1 15/32")		20223



		mm (inch)	20222	20223	No.
Set consisting of:					
	Inset profile for concrete surfaces, with fixed glass, aluminum	3,000 (9' 10 1/8 ")	1		20100
	Polystyrene insert, 1000 mm (3'3 1/4 "), with fixed glass	1,000 (3' 3 3/8 ")	3	4	19558
	Assembly clips, plastic black, with fixed glass		4	5	19569
	Cover cap, fixed glass, plastic, gray		2	2	19970
	Inset profile for concrete surfaces, with fixed glass, aluminum	4,000 (13' 1 15/32")		1	20098

Assembly set for Hawa Adapto 120

	No.
Assembly set, with countersunk head screw, length up to 2500 mm (8'2 7/16")(8'2 7/16")	22841
Assembly set, with countersunk head screw, length 2501–4000 mm (8'2 15/32"–13'1 15/32")	22842
Assembly set, with countersunk head screw, length 4001–6000 mm (13'1 17/32"–19'8 7/32")	22843

Set consisting of:				No.
	22841	22842	22843	
 Distance plate, plastic, 1 mm (1/32")	2	2	3	19398
 Distance plate, plastic, 2 mm (3/32")	2	2	3	19399
 Distance plate, plastic, 3 mm (1/8")	2	2	3	19400
 Distance plate, plastic, 5 mm (3/16")	4	4	6	19401
 Countersunk screws special, 6x20 mm (1/4"x25/32"), 10-piece set	1	2	3	22844

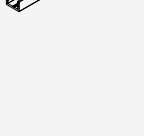

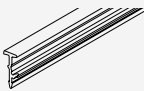
Base/wall profiles and rubber profiles for fixed glazing

	mm (inch)	No.
	4,000 (13' 1 15/32")	19549
	6,000 (19' 8 7/32")	19561
	cut to size	20067
	4,000 (13' 1 15/32")	21285
	6,000 (19' 8 7/32")	21286
	cut to size	21287
	10,000 (32'9 11/16")	25787
	10,000 (32'9 11/16")	25789
	10,000 (32' 9 11/16")	25763



Vertical sealing profiles

		mm (inch)	No.
	Vertical seal 13/18, aluminum, anodized, for fixed glass with glass distance 13-18,5 mm (1/2"-3/4")	2,500 (8' 2 7/16")	20283
		3,500 (11' 5 25/32")	20284
	Vertical seal 13/18, aluminum, stainless steel look, brushed, for fixed glass distance 13-18,5 mm (1/2"-3/4")	2,500 (8' 2 7/16")	21290
		3,500 (11' 5 25/32")	21291
	Vertical seal 20/22, aluminum, anodized, for fixed glass with glass distance 20–22 mm (25/32"–7/8")	2,500 (8' 2 7/16")	20650
		3,500 (11' 5 25/32")	20651







Wall connection

		mm (inch)	No.
	Wall profile, aluminum, anodized	2,500 (8' 2 7/16")	17020
		3,500 (11' 5 25/32")	17021
	Wall profile, aluminum, stainless steel look, brushed	2,500 (8' 2 7/16")	20119
		3,500 (11' 5 25/32")	20120
	Seal profile, black, for wall profile	2,500 (8' 2 7/16")	16452
		3,500 (11' 5 25/32")	16453

Protective edge trims

		mm (inch)	No.
	Protective edge trim, for 10 mm glass (13/32"), plastic, transparent	3,000 (9' 10 1/8 ")	13822
		6,000 (19' 8 7/32 ")	13600
	Protective edge trim, for 12 mm glass (15/32"), plastic, transparent	3,000 (9' 10 1/8 ")	13908
		6,000 (19' 8 7/32 ")	13907
	Protective edge trim, for 12.7 mm glass (1/2"), plastic, transparent	3,000 (9' 10 1/8 ")	13912
		6,000 (19' 8 7/32 ")	13911
	Double-sided adhesive tape for protective edge trim	50,000 (164' 1/2 ")	22820
	Rubber profile self-adhesive, black, for 8–12,7 mm (5/16"–1/2") glass thickness, glass distance 4 mm	5,000 (16' 4 27/32 ")	19442
		10,000 (32' 9 11/16 ")	19443
		50,000 (164' 1/2 ")	19444
	Rubber profile self-adhesive, translucent, for 8–12,7 mm (5/16"–1/2") glass thickness, glass distance 4 mm	5,000 (16' 4 27/32 ")	19445
		10,000 (32' 9 11/16 ")	19446
		50,000 (164' 1/2 ")	19447





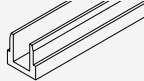

Integrated locks

		No.
	Bar bolt lock for 17 mm profile cylinder (21/32"), with retention pin	16760
	Bar bolt lock for 22 mm round cylinder (7/8"), with retention pin	16761
	Bar bolt lock for square/hexagon socket, with retention pin	16762
	Bar bolt lock for 17 mm (21/32") profile cylinder, with guide pin and fixing parts	18484
	Bar bolt lock for 22 mm (7/8") round cylinder, with guide pin and fixing parts	18485
	Bar bolt lock for square/hexagon socket with guide pin and fixing parts	18486
	Security rose 16 mm (5/8"), for profile cylinder 17/61 mm (21/32"/2 13/32"), chrome nickel steel	18502
	Spacer for security rose for 17 mm (21/32") profile cylinder, 10 mm (13/32") glass	18493
	Spacer for security rose for 22 mm (7/8") round cylinder, 10 mm (13/32") glass	18494
	Floor-mounted sleeve with oblong hole and chromium-plated brass spring cover	13787
	Rosette for floor-mounted sleeve	17326
	Strike plate, steel, chrome-plated	13130

Fixed Glass

		mm (inch)	No.
	Bottom profile for stationary glass and wood element, aluminum, anodized	6,000 (19' 8 7/32 ")	14691
		cut to size	14692

Accessories

		No.
	Cover cap, chrome-plated, matt, suitable to both sides	25332
	Fixing plate for fixed glass, with suspension bolt M12	15472
	Bottom door stopper, with centering, stainless steel look	21473
	Bottom door stopper, with centering, chrome-plated, matt	20773
	Hawa assembly wegde, for 1 door	15770
	Centering assembly grey, for all glass sliding doors	18619
	Centering assembly black, for all glass sliding doors, to wall profile	18663

Angled profile for wall mounting

The intelligent wall mounting with the angled profile for Hawa Junior running tracks for a door weight of up to 120 kg (264 lbs.).

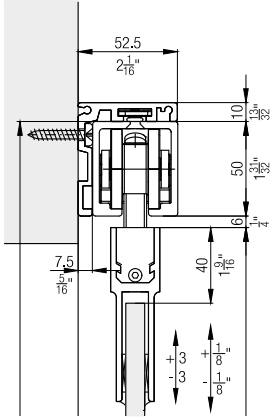

Hawa Adpto 120 concrete casting system

The Hawa Adpto 120 concrete casting system can be easily and efficiently integrated into the building shell and allows Hawa Junior 120 running tracks to be installed flush with the ceiling.

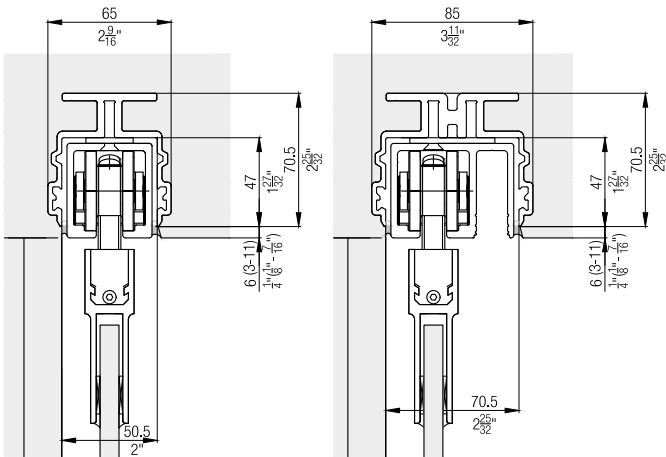

Base/wall profile for fixed glazing

The retainer profile, placed on the floor or flush with the floor, ensures the stability of the fixed glass panels.

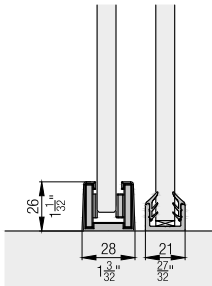

Vertical sealing profile

The vertical sealing profile is effective against draughts. The slim aluminium profile affixes frontally to glass elements 8–12 mm (5/16" to 15/32") thick using silicone adhesive. The two-part rubber seal is recessed into the profile and it slides almost noiselessly and creates minimal resistance to motion.

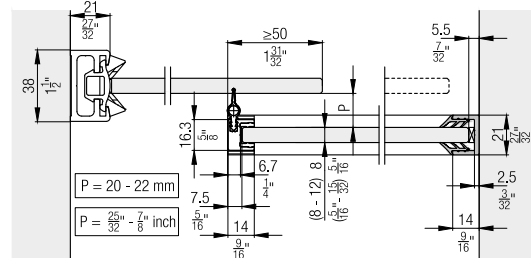

Wall connection

Optimal wall connection for all-glass sliding doors with unprotected glass edge.

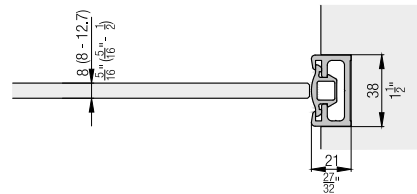

Glass edge protection

The transparent glass edge protection profile and the self-adhesive rubber profile are recommended for protecting the vertical glass edges. The latter not only protects the glass edges, it also reduces draughts to a minimum.

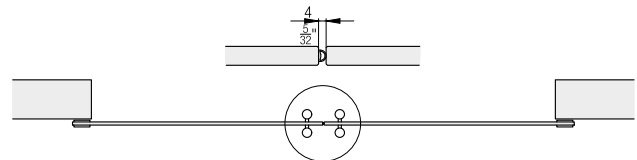

Integrated locks

An integrated bar bolt lock, suitable for the 17 mm (21/32") profile cylinder, 22 mm (7/8") round cylinder and a square/hexagonal socket, is available to secure the all-glass sliding doors.

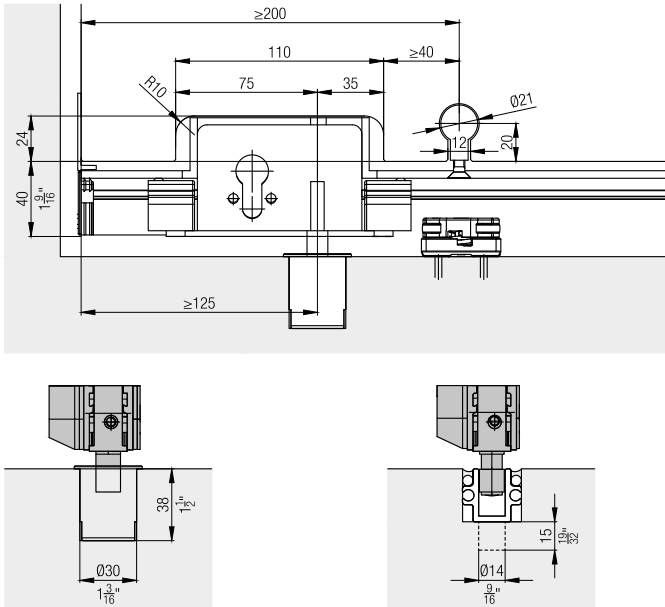

Individual solution

The suspension profile (12915) allows for the use of commercial as well as customer-specific suspension and glass retaining profiles.

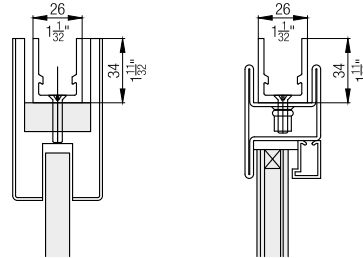

SoftMove 120 soft closing mechanism

Completely integrated into the running track, the SoftMove decelerates sliding doors and draws them into their final position.

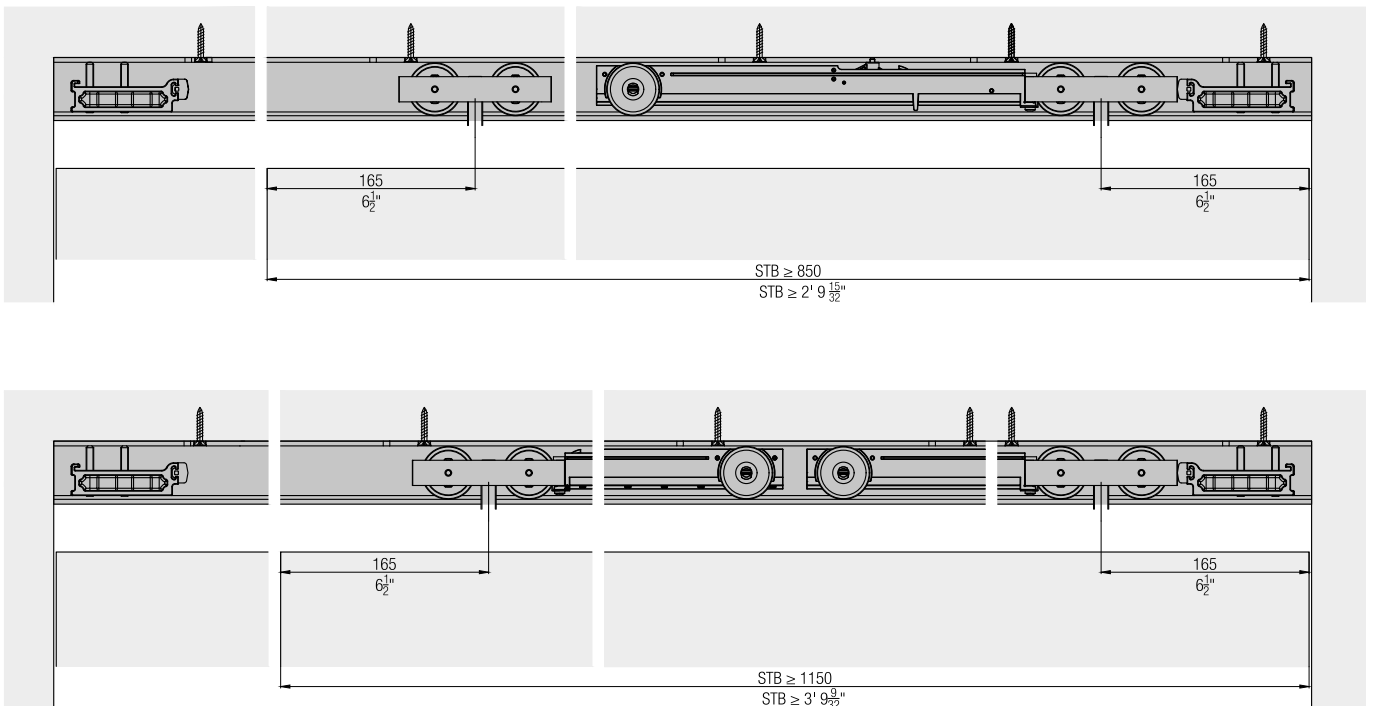

Accessories

- Lock solutions from page 511
- General accessories from page 518
- Glass recommendations from page 536

Planning/execution

Further information about the product can be found on www.hawa.com.