







Hardware for pivoting, folding and lateral sliding in of wooden doors up to 20 kg (44 lbs.). Uniform, flush front design with even gap pattern. Invisible technology. Pull version with handle.

Product highlights

-  **Flexibility** Variable door dimensions, also for floor-to-ceiling, walk-in closets – can be combined with Hawa Concepta III
-  **Productivity** Easy installation thanks to high degree of pre-assembly and intuitive adjustment
-  **Comfort** Opening and closing with very little effort – one hand is enough

Technical specifications

-  6–20 kg (13 to 44 lbs.)
-  1200–2200 mm (3' 11 1/4" to 7' 2 5/8")
-  440–750 mm (1' 5 5/16" to 2' 5 17/32")
-  18–26 mm (23/32" to 1 1/32")

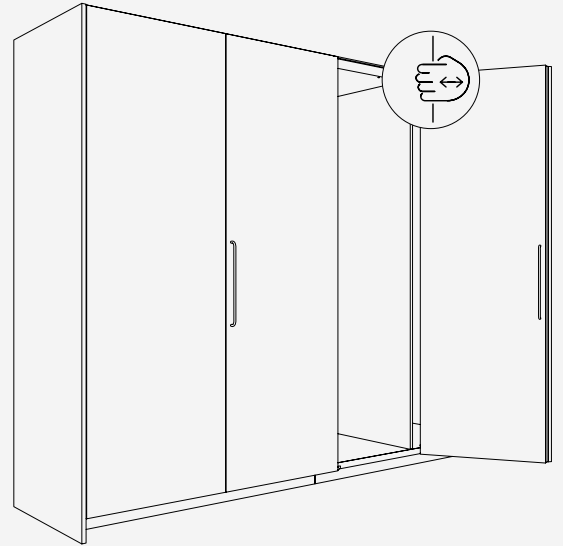

Installation examples

Overlay door without base profile

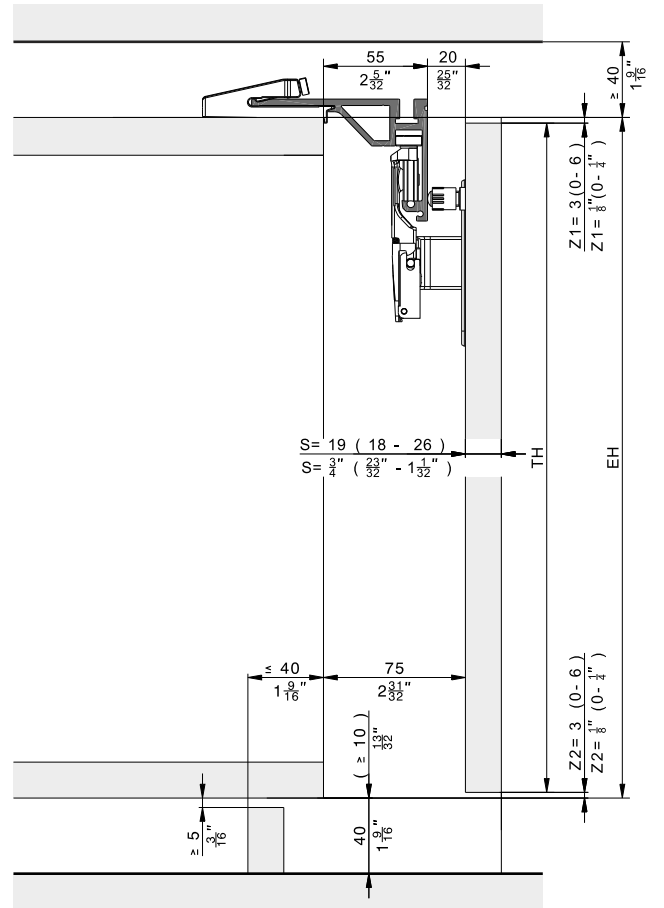
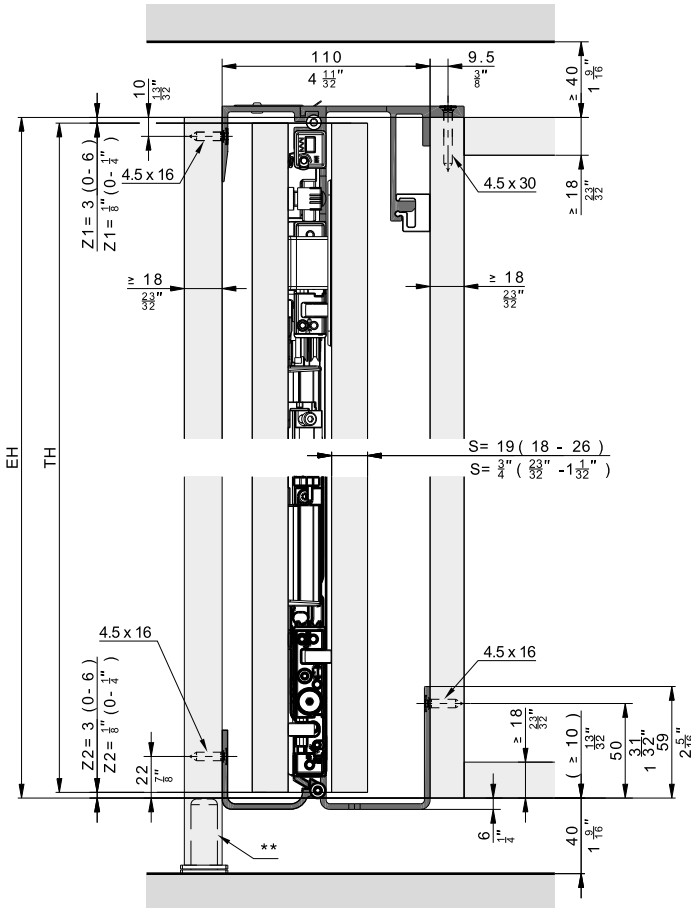

** Recommendation: Use adjustable foot

Overlay door without base profile, 2 and 4 doors

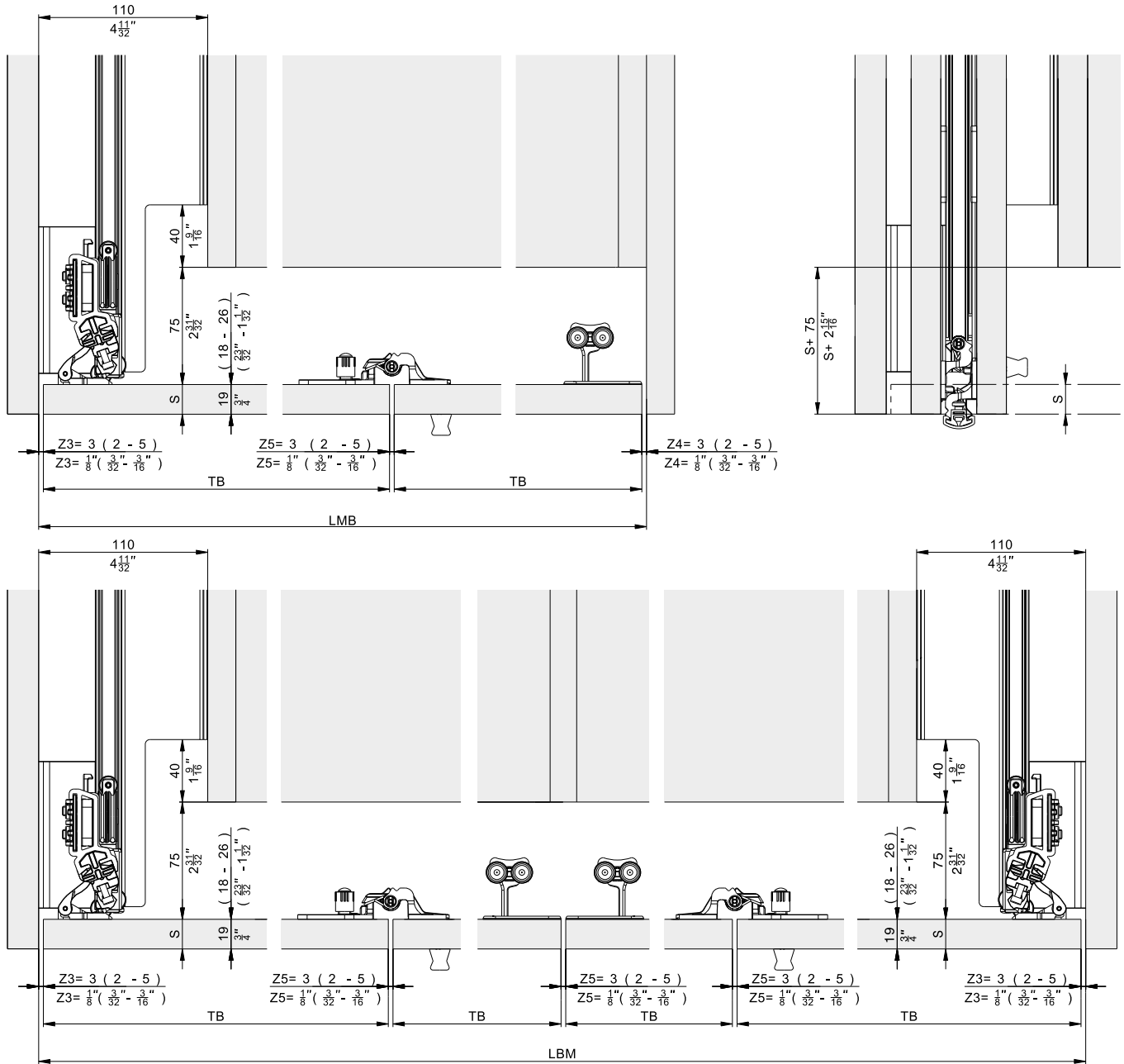

Required components

for 2-door cabinets

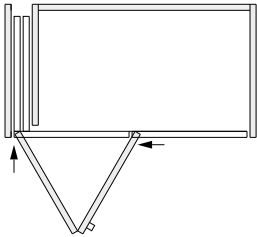

Hawa Folding Concepta III 20 Pull, left
Aluminum, anodized

	No.
Hawa Folding Concepta III 20 Pull, basic set, door height 1200–2200 mm (3' 11 1/4" to 7' 2 5/8")	31506
Hawa Folding Concepta III 20/25 Pull, slide-in set, left	31512
Hawa Folding Concepta III 20/25, track set 2 doors, left, aluminum, anodized	31514
Hawa Folding Concepta III 20, upright set, door height 1200–2200 mm (3' 11 1/4" to 7' 2 5/8"), aluminum, anodized	31519

Aluminum, black anodized

	No.
Hawa Folding Concepta III 20 Pull, basic set, door height 1200–2200 mm (3' 11 1/4" to 7' 2 5/8")	31506
Hawa Folding Concepta III 20/25 Pull, slide-in set, left	31512
Hawa Folding Concepta III 20/25, track set 2 doors, left, aluminum, black anodized	31521
Hawa Folding Concepta III 20, upright set, door height 1200–2200 mm (3' 11 1/4" to 7' 2 5/8"), aluminum, black anodized	31526

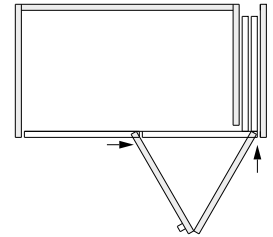

Hawa Folding Concepta III 20 Pull, right
Aluminum, anodized

	No.
Hawa Folding Concepta III 20 Pull, basic set, door height 1200–2200 mm (3' 11 1/4" to 7' 2 5/8")	31506
Hawa Folding Concepta III 20/25 Pull, slide-in set, right	31513
Hawa Folding Concepta III 20/25, track set 2 doors, right, aluminum, anodized	31515
Hawa Folding Concepta III 20, upright set, door height 1200–2200 mm (3' 11 1/4" to 7' 2 5/8"), aluminum, anodized	31519

Aluminum, black anodized

	No.
Hawa Folding Concepta III 20 Pull, basic set, door height 1200–2200 mm (3' 11 1/4" to 7' 2 5/8")	31506
Hawa Folding Concepta III 20/25 Pull, slide-in set, right	31513
Hawa Folding Concepta III 20/25, track set 2 doors, right, aluminum, black anodized	31522
Hawa Folding Concepta III 20, upright set, door height 1200–2200 mm (3' 11 1/4" to 7' 2 5/8"), aluminum, black anodized	31526

for 4-door cabinets

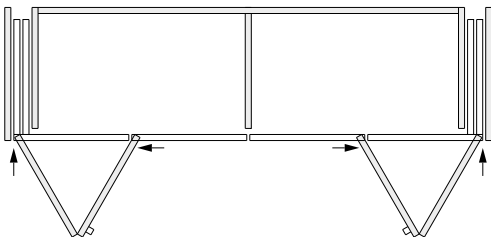

Hawa Folding Concepta III 20 Pull, left/right
Aluminum, anodized

	Pcs.	No.
Hawa Folding Concepta III 20 Pull, basic set, door height 1200–2200 mm (3' 11 1/4" to 7' 2 5/8")	2	31506
Hawa Folding Concepta III 20/25 Pull, slide-in set, left	1	31512
Hawa Folding Concepta III 20/25 Pull, slide-in set, right	1	31513
Hawa Folding Concepta III 20/25, track set 4 doors, aluminum, anodized	1	31518
Hawa Folding Concepta III 20, upright set, door height 1200–2200 mm (3' 11 1/4" to 7' 2 5/8"), aluminum, anodized	2	31519

Aluminum, black anodized

	Pcs.	No.
Hawa Folding Concepta III 20 Pull, basic set, door height 1200–2200 mm (3' 11 1/4" to 7' 2 5/8")	2	31506
Hawa Folding Concepta III 20/25 Pull, slide-in set, left	1	31512
Hawa Folding Concepta III 20/25 Pull, slide-in set, right	1	31513
Hawa Folding Concepta III 20/25, track set 4 doors, aluminum, black anodized	1	31525
Hawa Folding Concepta III 20, upright set, door height 1200–2200 mm (3' 11 1/4" to 7' 2 5/8"), aluminum, black anodized	2	31526

for 3-door cabinets

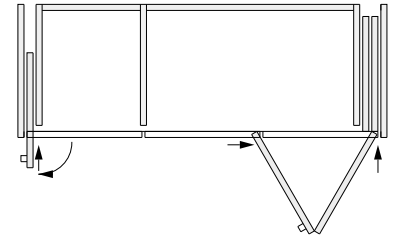
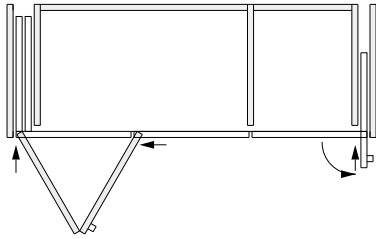

**Hawa Folding Concepta III 20 Pull, left with
Hawa Concepta III 25 Pull, right**

Aluminum, anodized

	No.
Hawa Folding Concepta III 20 Pull, basic set, door height 1200–2200 mm (3' 11 1/4" to 7' 2 5/8")	31506
Hawa Folding Concepta III 20/25 Pull, slide-in set, left	31512
Hawa Folding Concepta III 20/25, track set 3 doors, left, aluminum, anodized	31516
Hawa Folding Concepta III 20, upright set, door height 1200–2200 mm (3' 11 1/4" to 7' 2 5/8"), aluminum, anodized	31519
Hawa Concepta III 25 Push/Pull, basic set right, door height 1200–2200 mm (3' 11 1/4" to 7' 2 5/8")	30995
Hawa Concepta III 25/35 Pull, slide-in set, right	31001
Upright profile, for door height 1200–2200 mm (3' 11 1/4" to 7' 2 5/8"), aluminum, anodized, L= 1974 mm (6' 5 23/32")	30778
Connector set 55 mm (2 5/32"), for exterior connection to cabinet	31005

Aluminum, black anodized

	No.
Hawa Folding Concepta III 20 Pull, basic set, door height 1200–2200 mm (3' 11 1/4" to 7' 2 5/8")	31506
Hawa Folding Concepta III 20/25 Pull, slide-in set, left	31512
Hawa Folding Concepta III 20/25, track set 3 doors, left, aluminum, black anodized	31523
Hawa Folding Concepta III 20, upright set, door height 1200–2200 mm (3' 11 1/4" to 7' 2 5/8"), aluminum, black anodized	31526
Hawa Concepta III 25 Push/Pull, basic set right, door height 1200–2200 mm (3' 11 1/4" to 7' 2 5/8")	30995
Hawa Concepta III 25/35 Pull, slide-in set, right	31001
Upright profile, for door height 1200–2200 mm (3' 11 1/4" to 7' 2 5/8"), aluminum, anodized, L= 1974 mm (6' 5 23/32")	30778
Connector set 55 mm (2 5/32"), for exterior connection to cabinet	31005

**Hawa Folding Concepta III 20 Pull, right with
Hawa Concepta III 25 Pull, left**

Aluminum, anodized

	No.
Hawa Folding Concepta III 20 Pull, basic set, door height 1200–2200 mm (3' 11 1/4" to 7' 2 5/8")	31506
Hawa Folding Concepta III 20/25 Pull, slide-in set, right	31513
Hawa Folding Concepta III 20/25, track set 3 doors, right, aluminum, anodized	31517
Hawa Folding Concepta III 20, upright set, door height 1200–2200 mm (3' 11 1/4" to 7' 2 5/8"), aluminum, anodized	31519
Hawa Concepta III 25 Push/Pull, basic set left, door height 1200–2200 mm (3' 11 1/4" to 7' 2 5/8")	30994
Hawa Concepta III 25/35 Pull, slide-in set, left	31000
Upright profile, for door height 1200–2200 mm (3' 11 1/4" to 7' 2 5/8"), aluminum, anodized, L= 1974 mm (6' 5 23/32")	30778
Connector set 55 mm (2 5/32"), for exterior connection to cabinet	31005













Aluminum, black anodized

	No.
Hawa Folding Concepta III 20 Pull, basic set, door height 1200–2200 mm (3' 11 1/4" to 7' 2 5/8")	31506
Hawa Folding Concepta III 20/25 Pull, slide-in set, right	31513
Hawa Folding Concepta III 20/25, track set 3 doors, right, aluminum, black anodized	31524
Hawa Folding Concepta III 20, upright set, door height 1200–2200 mm (3' 11 1/4" to 7' 2 5/8"), aluminum, black anodized	31526
Hawa Concepta III 25 Push/Pull, basic set left, door height 1200–2200 mm (3' 11 1/4" to 7' 2 5/8")	30994
Hawa Concepta III 25/35 Pull, slide-in set, left	31000
Upright profile, for door height 1200–2200 mm (3' 11 1/4" to 7' 2 5/8"), aluminum, anodized, L= 1974 mm (6' 5 23/32")	30778
Connector set 55 mm (2 5/32"), for exterior connection to cabinet	31005





Hawa Configurator

List of individual parts, which are included in the sets

Set for 1 folding/slide-in door up to 20 kg (44 lbs.)

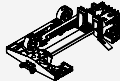
		No.	
Hawa Folding Concepta III 20 Pull, basic set, door height 1200–2200 mm (3' 11 1/4" to 7' 2 5/8")		31506	
		31506	No.
Set consisting of:			
	Slot nuts for hinge attachment, plastic, black	3	30686
	Mounting plate for hinge with height adjustment, steel, nickel-plated	1	30738
	Concealed hinge, with soft closing mechanism and closing spring, steel, nickel plated	3	31070
	Center concealed hinge, not spring loaded, steel, matt nickel-plated	3	31362
	Screw for concealed hinges and center concealed hinges, 4x16 mm (5/32"x5/8"), set of 20 pieces	1	31532
	Folding running gear, nickel-plated	1	31313
	Folding running gear hinge	1	31314
	Soft closing mechanism	1	31222
	Stop buffer adjustable, plastic, anthracite	1	31550
	Set of adjusting tools	1	31047
	Countersunk head screw, 4.5x16 mm (3/16"x5/8"), steel, zinc-plated, set of 28 pieces	1	31529
	Screw set for double running track and Connector attachment at the bottom	1	31530

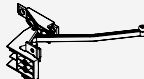





Suitable slide-in set

		No.	
Hawa Folding Concepta III 20/25 Pull, slide-in set, left		31512	
Hawa Folding Concepta III 20/25 Pull, slide-in set, right		31513	
		31512	31513
Set consisting of:			
	Slide-in unit Hawa Folding Concepta III 20/25 Pull, left	1	31004
	Pull end stop bracket, steel, zinc-plated	1	31541
	Slide-in securing mechanism, plastic, black	1	30966
	Slide-in unit Hawa Folding Concepta III 20/25 Pull, right	1	31046

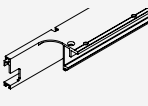
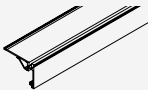
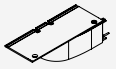
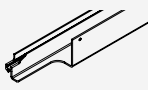
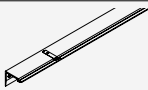
Suitable 2-door and 4-door track sets, aluminum, anodized





	No.
Hawa Folding Concepta III 20/25, track set 2 doors, left, aluminum, anodized	31514
Hawa Folding Concepta III 20/25, track set 2 doors, right, aluminum, anodized	31515
Hawa Folding Concepta III 20/25, track set 4 doors, aluminum, anodized	31518

Set consisting of:

		31514	31515	31518	No.
 Double running track top left, aluminum, anodized, L= 820 mm (2' 8 9/32")	1		1		31339
 Running track front, aluminum, anodized, L= 1272 mm (4' 2 3/32")	1	1			31210
 Running track curve, left, aluminum, anodized	1		1		31365
 Bottom guide track left, aluminum, anodized, L= 820 mm (2' 8 9/32")	1		1		31336
 Connector, top left L= 788 mm (2' 7 1/32")	1		1		31370
 Connecting profile for Connector, top, aluminum, L= 660 mm (2' 1 31/32")	1	1		2	30977
 Connector clips, bottom, plastic, black, L= 94 mm (3 11/16")	3	3		6	31086
 Connector part for running track curve, steel, zinc-plated	1	1		2	31543
 Double running track support, plastic, black	1	1		2	31359
 Running track adapter, plastic, anthracite, set of 4 pieces	1	1		2	23645

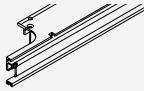
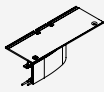

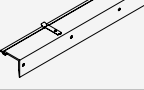
Continued table on next column

Table continued from previous column

 Countersunk head screw for running track adapter, 4.5x16 mm (3/16"x5/8"), set of 16 pieces	1	1	2		31585
 Double running track top right, aluminum, anodized, L= 820 mm (2' 8 9/32")		1	1		31340
 Running track curve, right, aluminum, anodized		1	1		31366
 Bottom guide track right, aluminum, anodized, L= 820 mm (2' 8 9/32")		1	1		31337
 Connector, top right, L= 788 mm (2' 7 1/32")		1	1		31371
 Running track front, aluminum, anodized, L= 2539 mm (8' 3 31/32")			1		31343

Upright set, aluminum, anodized

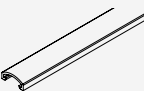







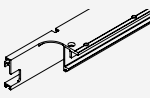
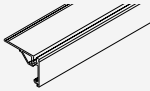
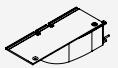

	No.
Hawa Folding Concepta III 20, upright set, door height 1200–2200 mm (3' 11 1/4" to 7' 2 5/8"), aluminum, anodized	31519

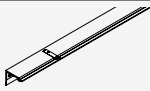
	31519	No.
 Upright profile, for door height 1200–2200 mm (3' 11 1/4" to 7' 2 5/8"), aluminum, anodized, L= 1974 mm (6' 5 23/32")	1	30778
 Cover panel for door joint, for door height 1200–2200 mm (3' 11 1/4" to 7' 2 5/8"), aluminum, anodized, L= 2200 mm (7' 2 5/8")	1	31230
 Retaining clip for cover panel 2200 mm (7' 2 5/8"), plastic, black, set of 6 pieces	1	31502

Suitable 3-door track sets, aluminum, anodized

	No.
Hawa Folding Concepta III 20/25, track set 3 doors, left, aluminum, anodized	31516
Hawa Folding Concepta III 20/25, track set 3 doors, right, aluminum, anodized	31517

Set consisting of:

		31516	31517	No.
	Double running track top left, aluminum, anodized, L= 820 mm (2' 8 9/32")	1		31339
	Running track front, aluminum, anodized, L= 1954 mm (6' 4 15/16")	1	1	31341
	Running track curve, left, aluminum, anodized	1		31365
	Bottom guide track left, aluminum, anodized, L= 820 mm (2' 8 9/32")	1		31336
	Connector, top left L= 788 mm (2' 7 1/32")	1		31370
	Connecting profile for Connector, top, aluminum, L= 660 mm (2' 1 31/32")	1	1	30977
	Connector clips, bottom, plastic, black, L= 94 mm (3 11/16")	3	3	31086
	Connector part for running track curve, steel, zinc-plated	1	1	31543
	Double running track support, plastic, black	1	1	31359
	Running track adapter, plastic, anthracite, set of 6 pieces	1	1	24870
	Stop set 3 doors Push/Pull	1	1	31538
	Countersunk head screw for running track adapter, 4.5x16 mm (3/16"x5/8"), set of 24 pieces	1	1	31587



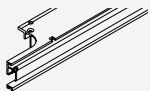
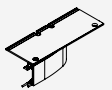
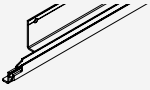
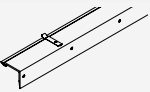

Continued table on next column

Table continued from previous column

	Double running track top right, aluminum, anodized, L= 820 mm (2' 8 9/32")	1		31340
	Running track curve, right, aluminum, anodized		1	31366
	Bottom guide track right, aluminum, anodized, L= 820 mm (2' 8 9/32")		1	31337
	Connector, top right L= 788 mm (2' 7 1/32")		1	31371

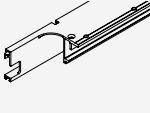
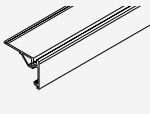
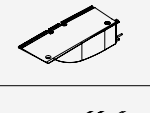

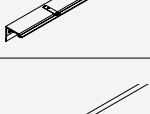
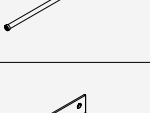
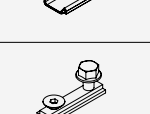
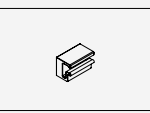
Suitable 2-door and 4-door track sets, aluminum, black anodized

	No.
Hawa Folding Concepta III 20/25, track set 2 doors, left, aluminum, black anodized	31521
Hawa Folding Concepta III 20/25, track set 2 doors, right, aluminum, black anodized	31522
Hawa Folding Concepta III 20/25, track set 4 doors, aluminum, black anodized	31525

Set consisting of:		31521	31522	31525	No.
	Double running track top left, aluminum, anodized, L= 820 mm (2' 8 9/32")	1	1		31339
	Running track front, aluminum, black anodized, L= 1272 mm (4' 2 3/32")	1	1		31211
	Running track curve, left, aluminum, black anodized	1		1	31367
	Bottom guide track left, aluminum, anodized, L= 820 mm (2' 8 9/32")	1		1	31336
	Connector, top left L= 788 mm (2' 7 1/32")	1		1	31370
	Connecting profile for Connector, top, aluminum, L= 660 mm (2' 1 31/32")	1	1	2	30977
	Connector clips, bottom, plastic, black, L= 94 mm (3 11/16")	3	3	6	31086
	Connector part for running track curve, steel, zinc-plated	1	1	2	31543
	Double running track support, plastic, black	1	1	2	31359
	Running track adapter, plastic, anthracite, set of 4 pieces	1	1	2	23645

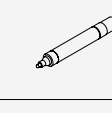
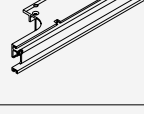
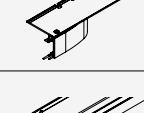
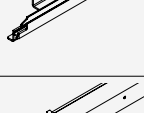
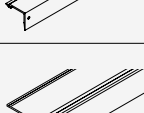

Continued table on next column

Table continued from previous column

	Countersunk head screw for running track adapter, 4.5x16 mm (3/16"x5/8"), set of 16 pieces	1	1	2	31585
	Cover-up pen for cut edge, black	1	1	1	52117
	Double running track top right, aluminum, anodized, L= 820 mm (2' 8 9/32")		1	1	31340
	Running track curve, right, aluminum, black anodized		1	1	31368
	Bottom guide track right, aluminum, anodized, L= 820 mm (2' 8 9/32")		1	1	31337
	Connector, top right L= 788 mm (2' 7 1/32")		1	1	31371
	Running track front, aluminum, black anodized, L= 2539 mm (8' 3 31/32")			1	31344

Upright set, aluminum, black anodized

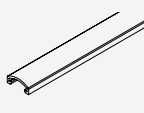





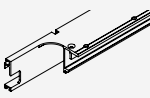
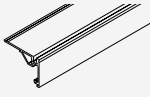
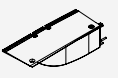
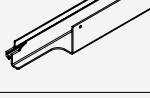
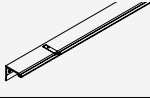

	No.
Hawa Folding Concepta III 20, upright set, door height 1200–2200 mm (3' 11 1/4" to 7' 2 5/8"), aluminum, black anodized	31526

Set consisting of:		31526	No.
	Upright profile, for door height 1200–2200 mm (3' 11 1/4" to 7' 2 5/8"), aluminum, anodized, L= 1974 mm (6' 5 23/32")	1	30778
	Cover panel for door joint, for door height 1200–2200 mm (3' 11 1/4" to 7' 2 5/8"), aluminum, black anodized, L= 2200 mm (7' 2 5/8")	1	31231
	Retaining clip for cover panel 2200 mm (7' 2 5/8"), plastic, black, set of 6 pieces	1	31502

Suitable 3-door track sets, aluminum, black anodized





	No.
Hawa Folding Concepta III 20/25, track set 3 doors, left, aluminum, black anodized	31523
Hawa Folding Concepta III 20/25, track set 3 doors, right, aluminum, black anodized	31524

Set consisting of:

		31523	31524	No.
	Double running track top left, aluminum, anodized, L= 820 mm (2' 8 9/32")	1		31339
	Running track front, aluminum, black anodized, L= 1954 mm (6' 4 15/16")	1	1	31342
	Running track curve, left, aluminum, black anodized	1		31367
	Bottom guide track left, aluminum, anodized, L= 820 mm (2' 8 9/32")	1		31336
	Connector, top left L= 788 mm (2' 7 1/32")	1		31370
	Connecting profile for Connector, top, aluminum, L= 660 mm (2' 1 31/32")	1	1	30977
	Connector clips, bottom, plastic, black, L= 94 mm (3 11/16")	3	3	31086
	Connector part for running track curve, steel, zinc-plated	1	1	31543
	Double running track support, plastic, black	1	1	31359
	Running track adapter, plastic, anthracite, set of 6 pieces	1	1	24870
	Stop set 3 doors Push/Pull	1	1	31538
	Countersunk head screw for running track adapter, 4.5x16 mm (3/16"x5/8"), set of 24 pieces	1	1	31587

Continued table on next column

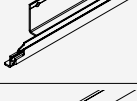
Table continued from previous column

	Cover-up pen for cut edge, black	1	1	52117
	Double running track top right, aluminum, anodized, L= 820 mm (2' 8 9/32")		1	31340
	Running track curve, right, aluminum, black anodized		1	31368
	Bottom guide track right, aluminum, anodized, L= 820 mm (2' 8 9/32")		1	31337
	Connector, top right, L= 788 mm (2' 7 1/32")		1	31371



Reinforcement profiles

	No.	
	Reinforcement profile for running track front, 2765 mm (9' 27/32"), 4 doors, aluminum, anodized	52109
	Reinforcement profile for running track front, 2085 mm (6' 10 3/32"), 3 doors, aluminum, anodized	52110

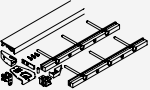
Base profiles

	No.	
	Base profile set, 2 doors, aluminum, anodized	52089
	Base profile set, 3 doors, aluminum, anodized	52090
	Base profile set, 4 doors, aluminum, anodized	52091
	Base profile set, 2 doors, aluminum, black anodized	52092
	Base profile set, 3 doors, aluminum, black anodized	52093
	Base profile set, 4 doors, aluminum, black anodized	52094

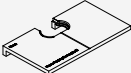
Accessories

	No.	
	Routing jig for folding hinge	52121
	Magnetic centering part, with including drilling jig, aluminum, anodized	24006

Straightening fitting

→ Details under accessories from page 323

Aluminum, untreated

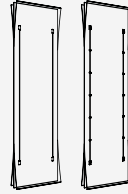
	No.	
	Straightening fitting for doors 1715–2275 mm (3' 11 27/32" to 5' 9 7/8"), aluminum	056.3192.079
	Straightening fitting for doors 1215–1775 mm (3' 11 27/32" to 5' 9 7/8"), aluminum	056.3192.073

Aluminum, anodized

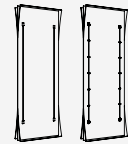
	Nr.	
	Straightening fitting for doors 1715–2275 mm (5' 7 17/32" to 7' 5 9/16"), aluminum, anodized, can be shortened for doors 1215–1715 mm (3' 11 27/32" to 5' 7 17/32")	056.3192.080

Aluminum, black anodized

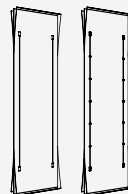
	No.	
	Straightening fitting for doors 1715–2275 mm (5' 7 15/32" to 7' 5 9/16"), aluminum, black anodized	056.3192.081
	Straightening fitting for doors 1215–1775 mm (3' 11 27/32" to 5' 9 7/8"), aluminum, black anodized	056.3192.076

Straightening fitting

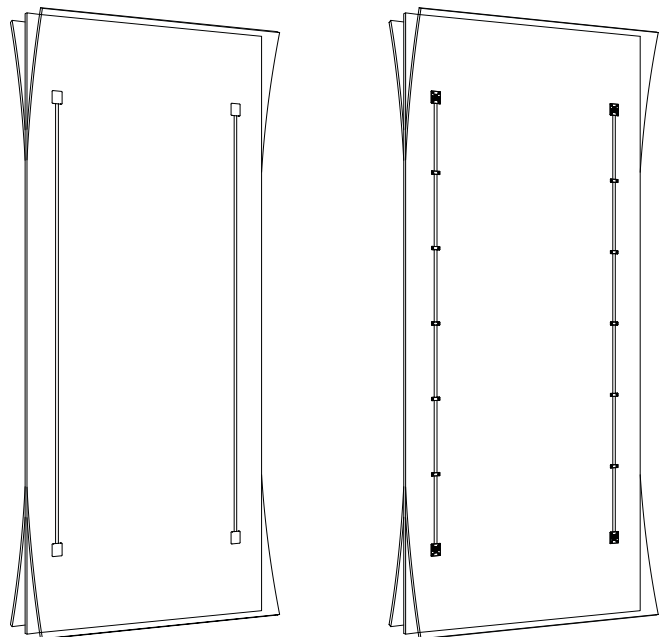

Further installation examples
 Overlay door with base profile, 2 and 4 doors

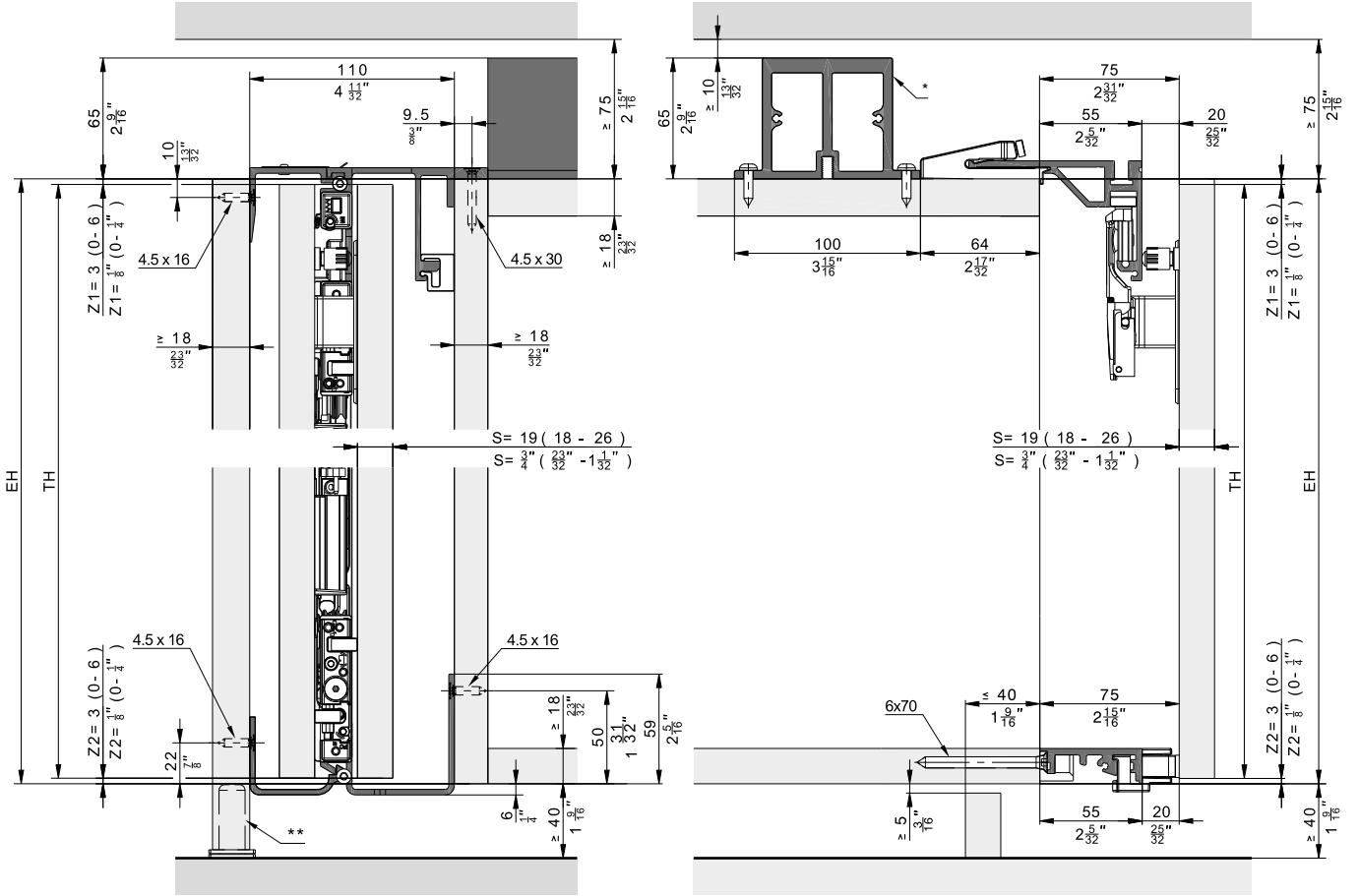

* Reinforcement profile for 3-door and 4-door systems without separating walls

** Recommendation: Use adjustable foot

Floor-to-ceiling doors without base panels,
2 doors and 4 doors

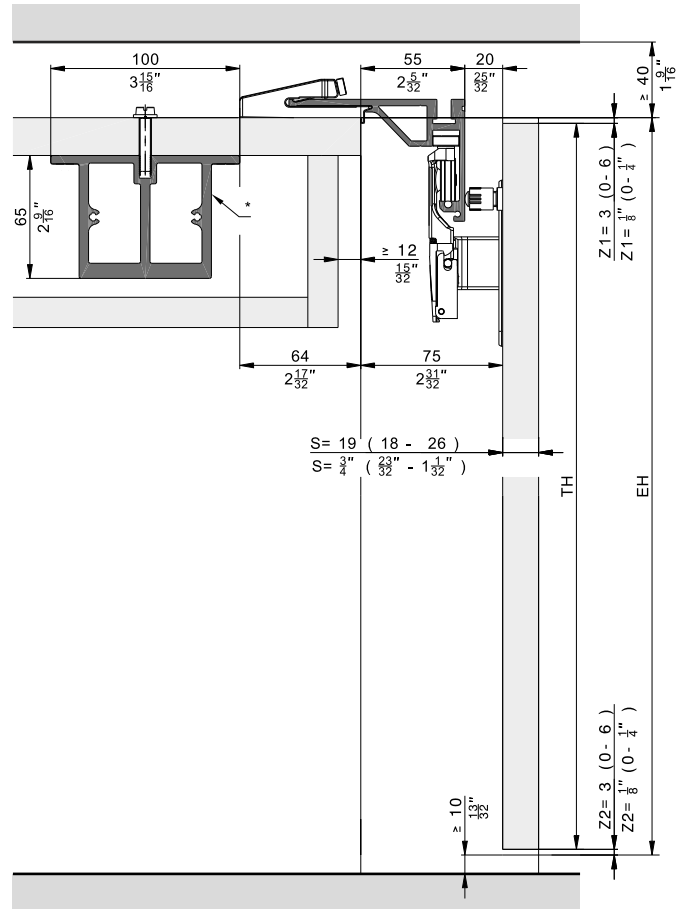
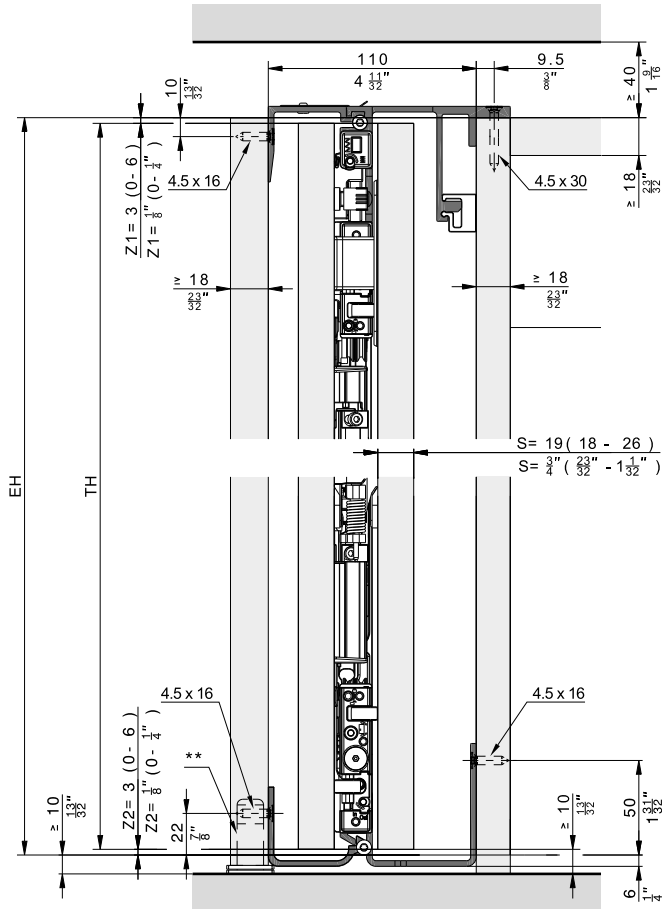

- * Reinforcement profile for 3-door and 4-door systems without separating walls
- ** Recommendation: Use adjustable foot

Overlay door without base profile, 3 doors

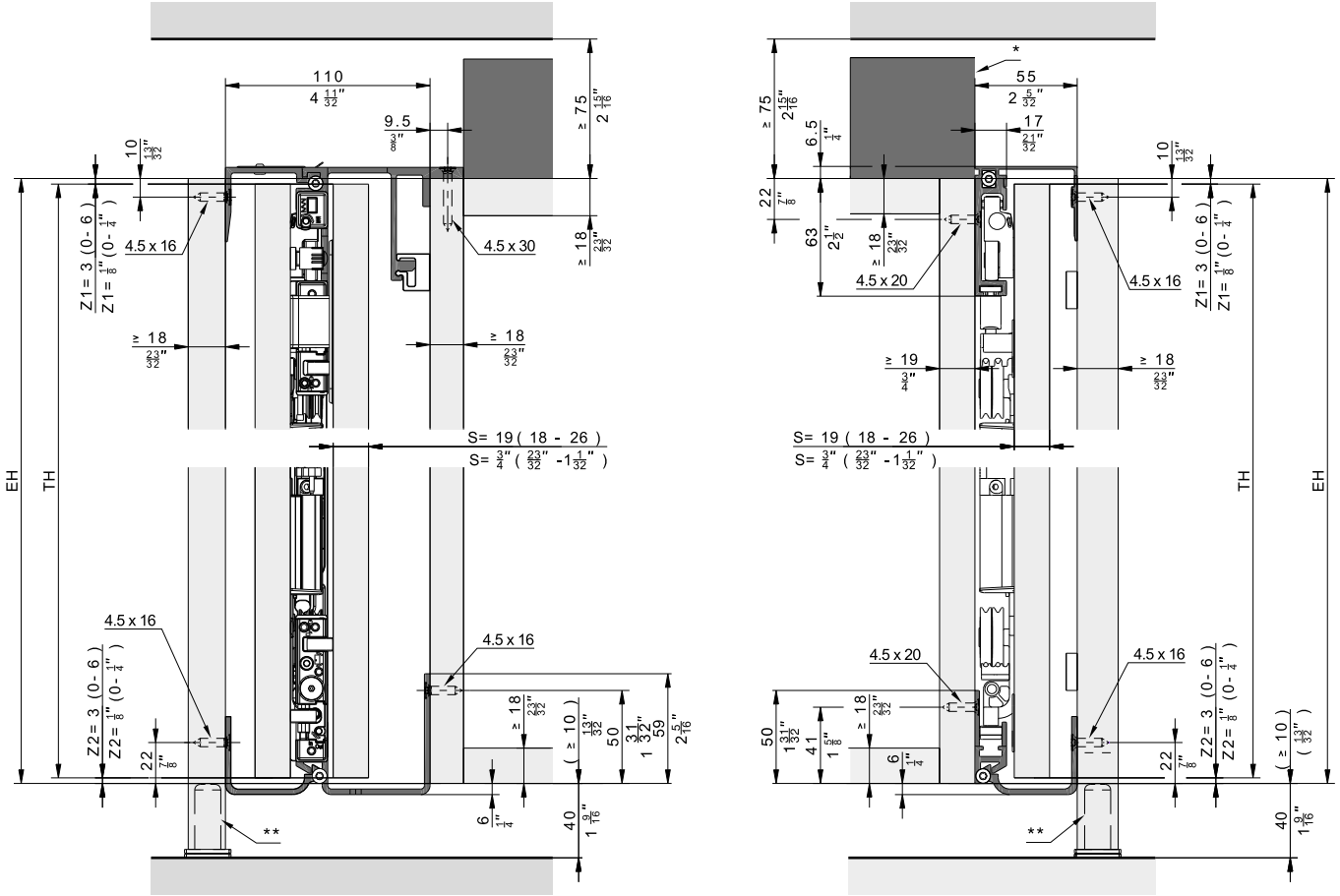

- * Reinforcement profile for 3-door and 4-door systems without separating walls
- ** Recommendation: Use adjustable foot

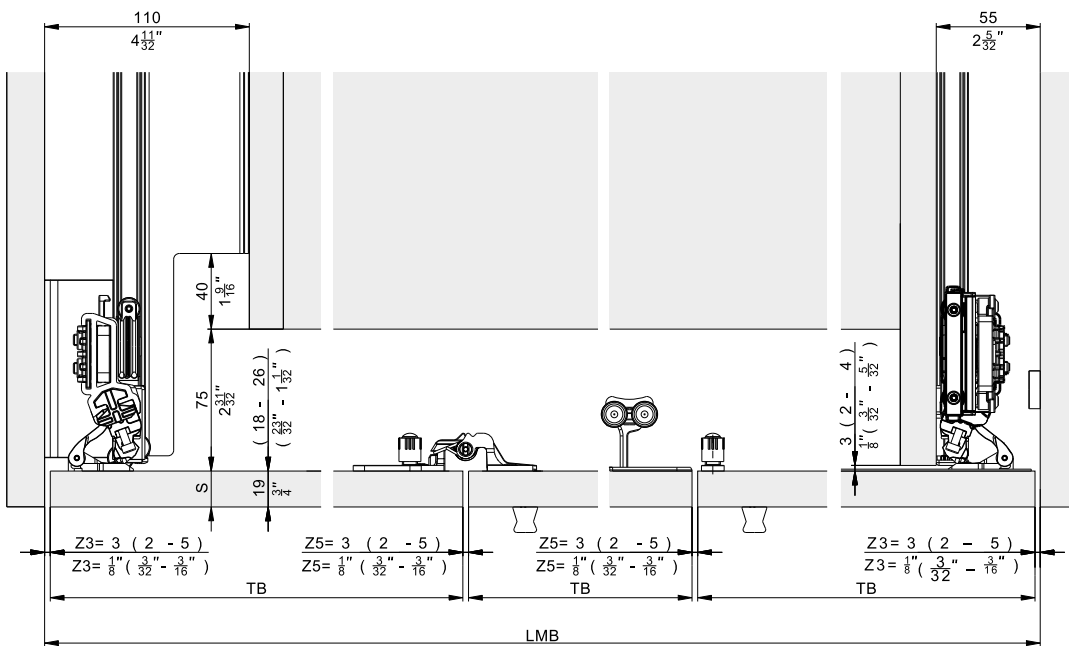

Hardware depth calculation

Flush door

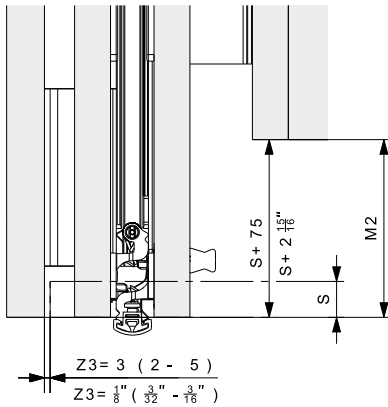

Protruding door

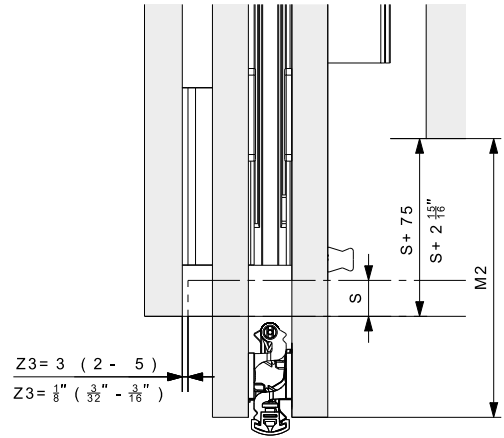

	mm	Inch
T2	TB + 92 + Z3 - M2	TB + 3 5/8" + Z3 - M2
E2	TB - M2	TB - M2
KT2	≥ T2	≥ T2
M2	≥ S + 75 ≤ TB - 390	≥ S + 2 1/16" ≤ TB - 1' 3 11/32"

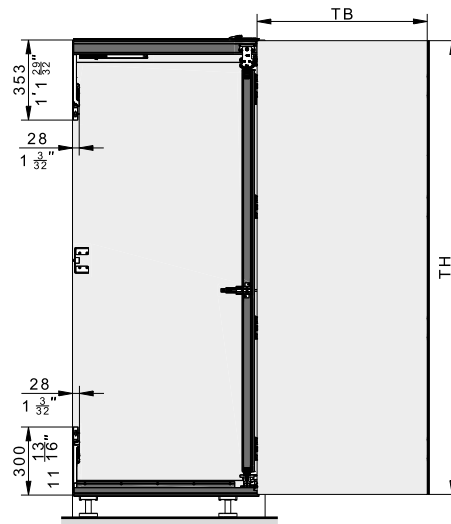
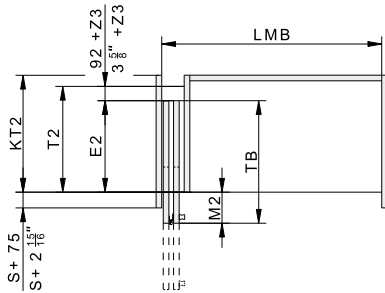

- S = Door thickness
- Z = Gap size
- E2 = Slide-in depth
- T2 = Hardware depth
- TB = Door width
- TH = Door height
- KT2 = Cabinet depth
- LMB = Inside clearance
- M2 = Door projection over cabinet

Accessories

– Straightening fitting from page 323

Planning/execution

Configure with just a few clicks at www.hawa.com/configurator

Further information about the product can be found on www.hawa.com.