



**Fitting for 2 top-running wooden doors up to 20 kg (44 lbs.), with screwed on running track and wooden or aluminum clip panel. Soft close optional. Design Mixslide.**

**Product highlights**

-  **Comfort** High operating convenience thanks to proven running system and optional soft closing technology
-  **Productivity** No cabinet processing, high degree of pre-assembly and access from the front for easy, quick installation

**Technical specifications**

-  Max. 20 kg (44 lbs.)
-  Max. 2200 mm (7'2 5/8")
-  Max. 1200 mm (3'11 1/4")
-  19 mm (3/4")

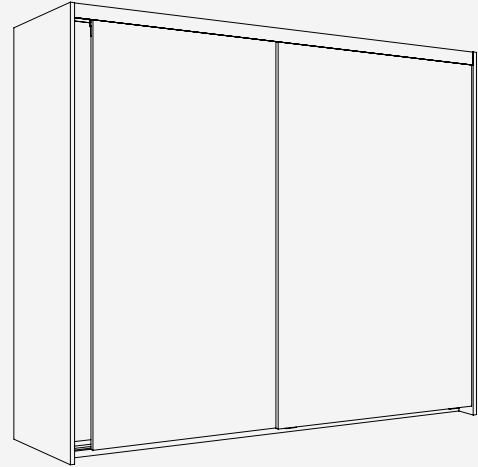

**Installation examples**

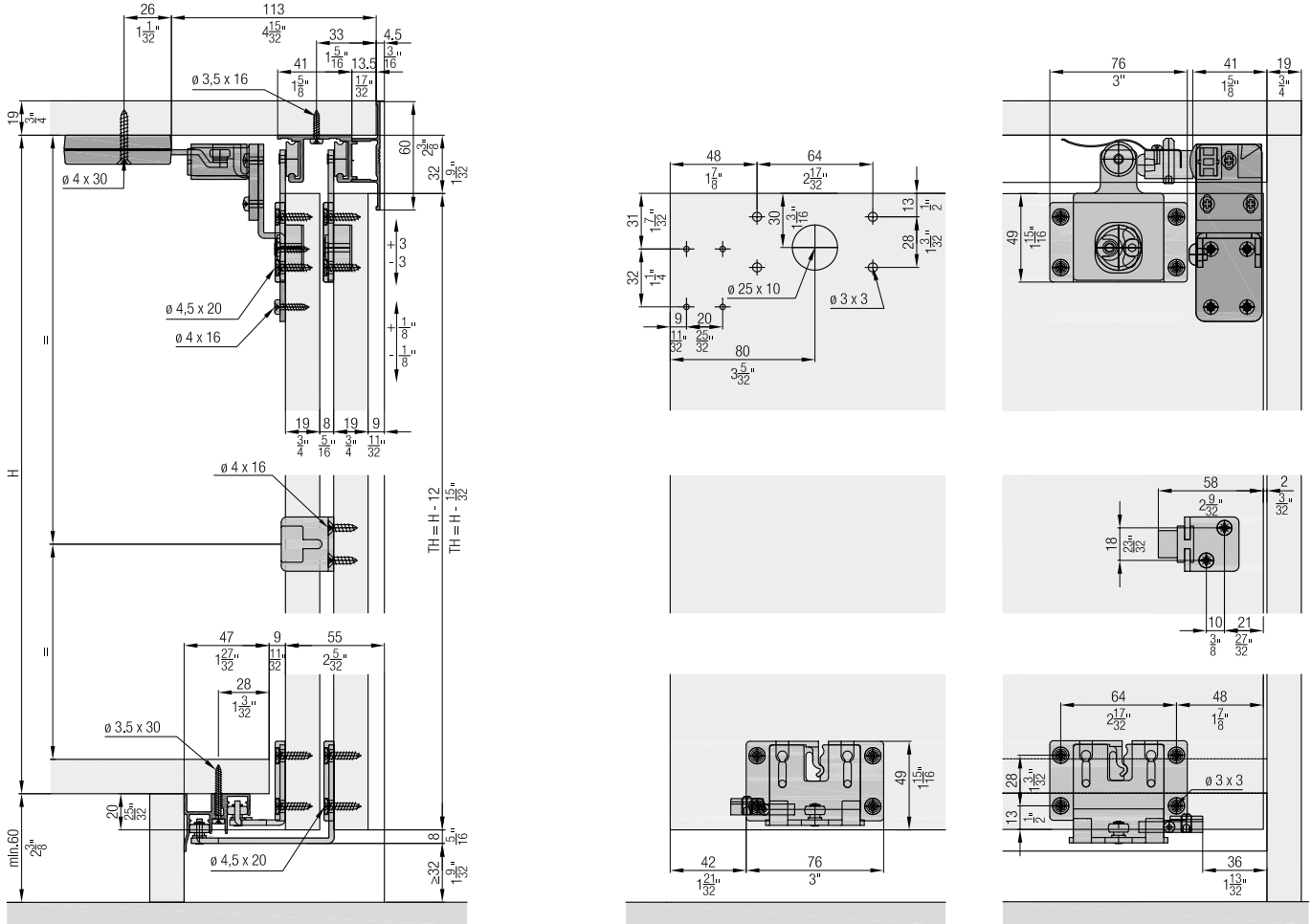

**Set for 2 wooden doors**

	No.
Hawa Combino 20 H MS, for 2 doors	056.3181.071

**Set consisting of:**

		056.3181.071	No.
	Running gear, steel, zinc-plated	4	056.3176.171
	Running gear housing, plastic, anthracite	4	056.3175.001
	Guide bracket, interior door, steel, zinc-plated	2	055.3107.171
	Guide bracket, exterior door, steel, zinc-plated	2	055.3108.171
	Guide bracket housing, plastic, anthracite	4	053.3064.001
	Stopper, plastic, gray	2	056.3189.071
	Stopper, with retention spring, plastic, gray	2	056.3189.072
	Stopper guide, plastic, gray	4	040.3079.074
	Door follower, with 2 doors, steel, zinc-plated	1	055.3124.071
	Countersunk head screw, 4.5x20 mm, steel, zinc-plated	32	600.0000.167

**Running tracks**

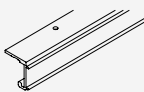
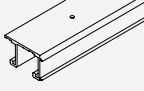
		mm (inch)	No.
	Single running track, aluminum, pre-drilled	2500 (8'2 7/16")	056.3011.250
		3500 (11'5 25/32")	056.3011.350
		6000 (19'8 7/32")	056.3011.600
	Double running track, aluminum, pre-drilled	2500 (8'2 7/16")	056.3010.250
		3500 (11'5 25/32")	056.3010.350
		6000 (19'8 7/32")	056.3010.600

**Guide tracks**

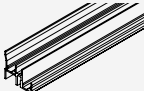
		mm (inch)	No.
	Double guide track, aluminum, anodized, pre-drilled	2500 (8'2 7/16")	056.3072.250
		3500 (11'5 25/32")	056.3072.350
		6000 (19'8 7/32")	056.3072.600

**Panels**





		mm (inch)	No.
	Clip-on panel, aluminum, anodized	2500 (8'2 7/16")	056.3174.250
		3500 (11'5 25/32")	056.3174.350
		6000 (19'8 7/32")	056.3174.600

**Soft close**

Adapter soft close must be ordered separately

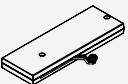
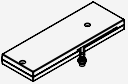
	No.
Soft close, up to 18 kg (40 lbs.), with wide follower, 2 pieces	055.3091.071
Soft close, 18-40 kg (40-88 lbs.), with wide follower, 2 pieces	055.3091.073

**Set consisting of:**

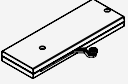
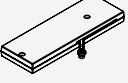
	055.3091.071	055.3091.073	No.
 Soft close, left, up to 18 kg (40 lbs.)	1		055.3090.071
 Soft close, right, up to 18 kg (40 lbs.)	1		055.3090.072
 Follower, for soft close, right, plastic, gray	1	1	055.3040.071
 Follower, for soft close, left, plastic, gray	1	1	055.3040.072
 Fillister head screw, 4x16 mm, steel, zinc-plated	6	6	600.0000.166
 Countersunk head screw, 4x30 mm, steel, zinc-plated	4	4	600.0000.439
 Soft close, left, 18-40 kg (40-88 lbs.)		1	055.3090.073
 Soft close, right, 18-40 kg (40-88 lbs.)		1	055.3090.074



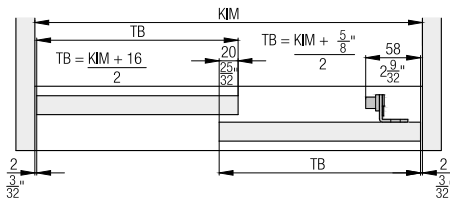

**Calculations**



**Adapter soft close for No. 055.3091.071 and 055.3091.073**

	No.
Adapter set, for soft close	055.3043.073

**Set consisting of:**

	055.3043.073	No.
 Adapter, for soft close, exterior door, steel, zinc-plated	1	055.0133.101
 Adapter, for soft close, interior door, steel, zinc-plated	1	055.0128.101
 Rounded head screw, M4x8 mm, steel, zinc-plated	6	759.0408.108
 Fillister head screw, 4x16 mm, steel, zinc-plated	8	600.0000.166
 Rubber buffer, plastic, grey	1	025.0107.001

**Accessories**

	No.
 Clip-on component, for wooden panel, every 500 mm (1'7 11/16\"), aluminum, pre-drilled	056.3039.001

**Optional: Installation with wooden panel**

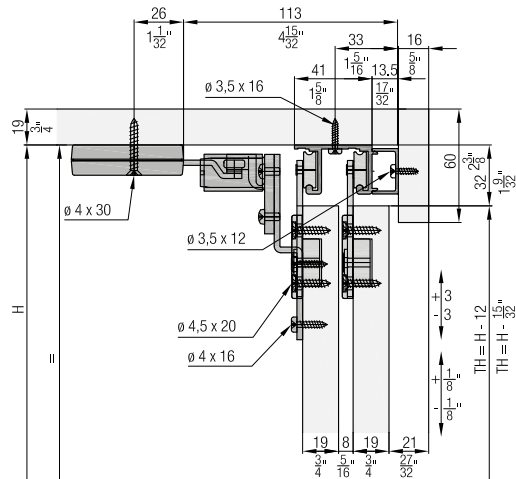

**Soft close**

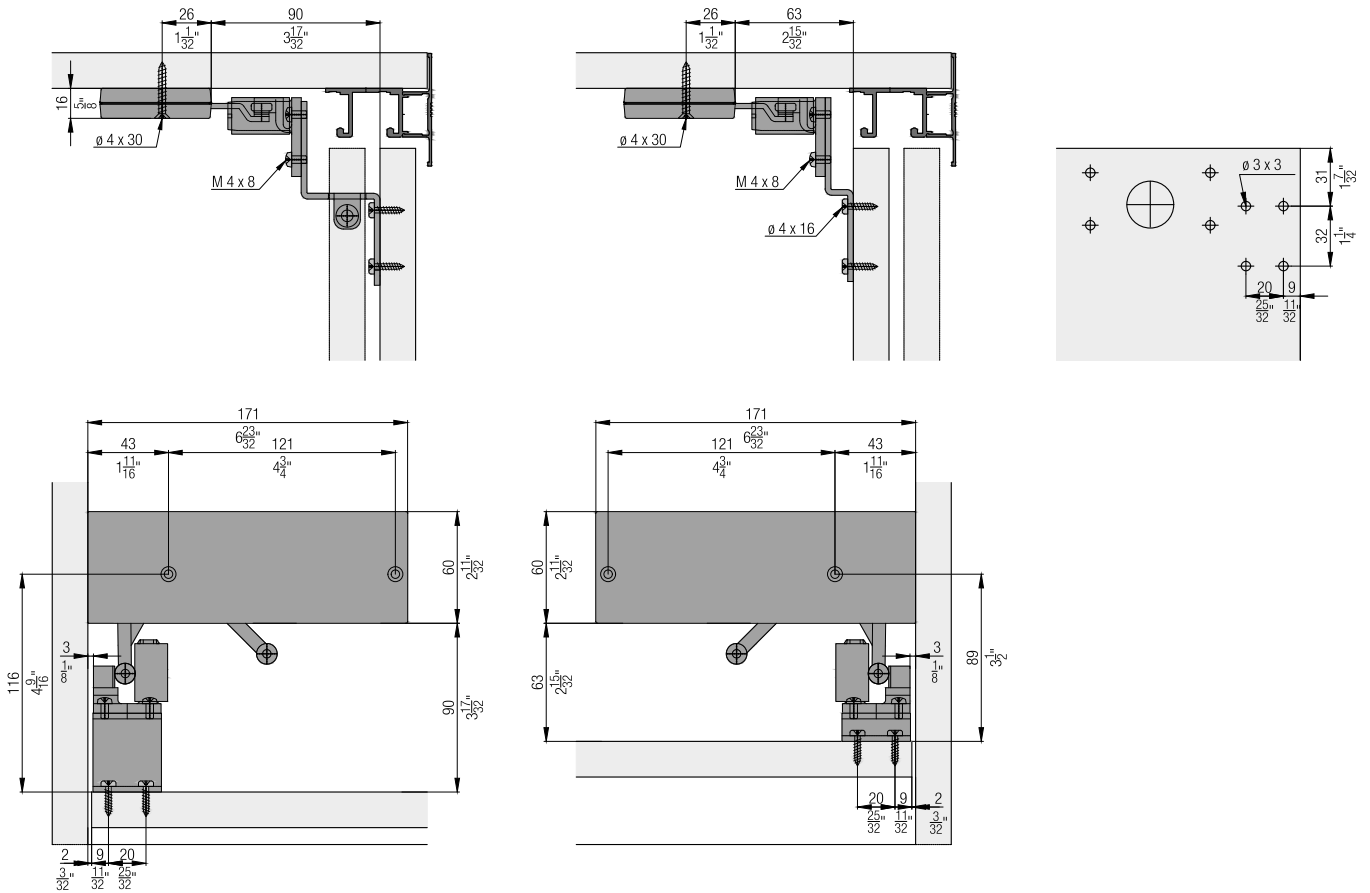

**Accessories**

- Straightening fitting from page 266
- Handle profiles from page 268
- Order overview soft close from page 270

**Planning/execution**

Further information about the product can be found on [www.hawa.com](http://www.hawa.com).