







**Fitting for 1 top-running glass door up to 36 kg (79 lbs.), with screwed on running track. With fixed glass support profile. With soft and self closing mechanism. Design Inside.**

**Product highlights**

-  **Comfort** Quiet, smooth running and soft and self closing system for different door weights
-  **Productivity** No groove in the base and invisible technology

**Technical specifications**

-  **Max.** 36 kg (79 lbs.)
-  **Max.** 2000 mm (6'6 3/4")
-  **Max.** 1000 mm (3'3 3/8")
-  **6-8 mm (1/4" to 5/16")**

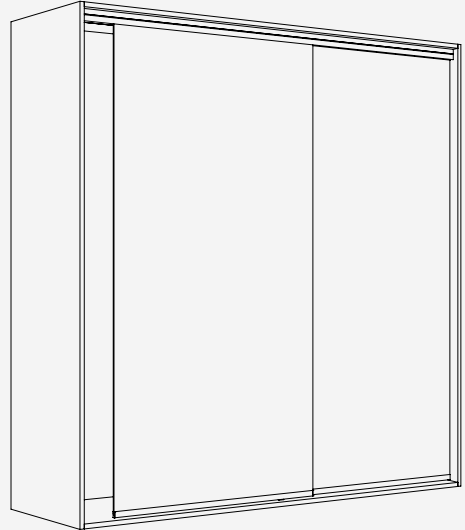

**Installation examples**



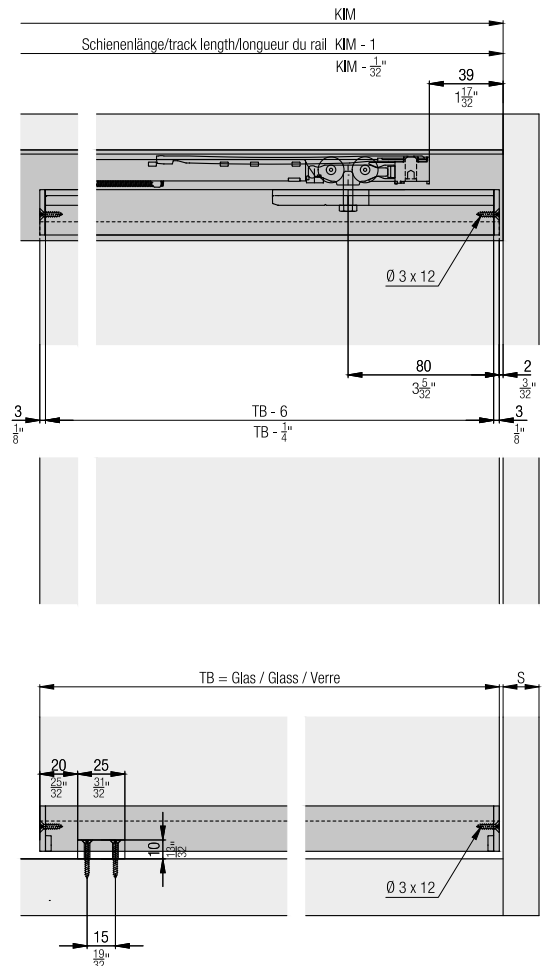
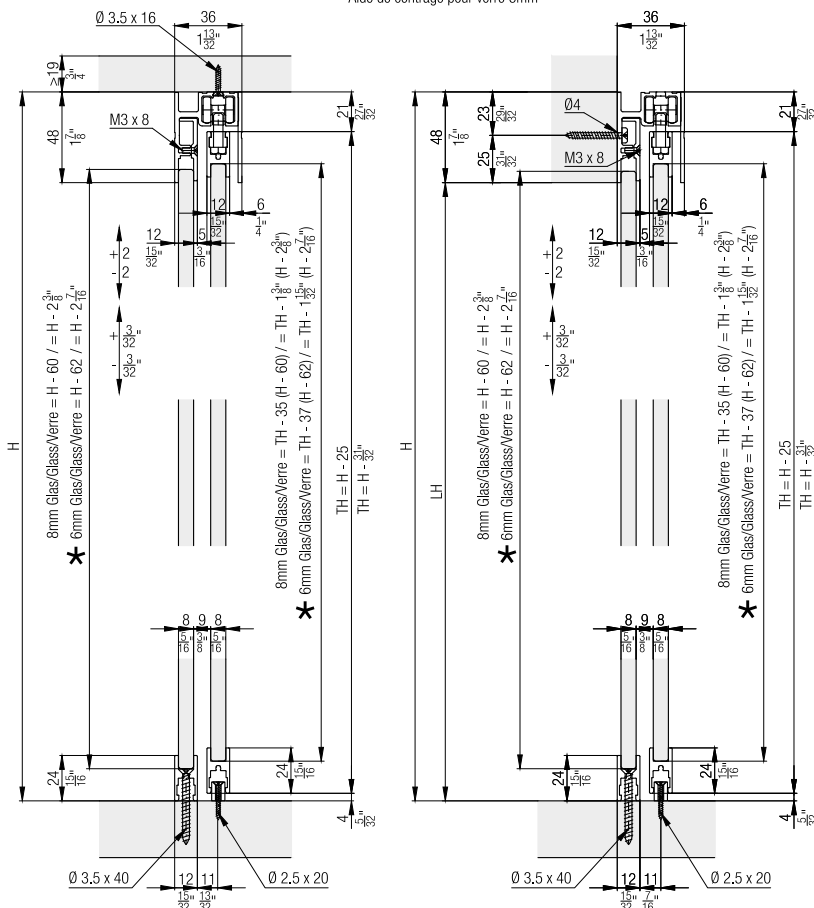



★ Zentrierhilfe für 6mm Glas  
Centering help for 6mm glass  
Aide de centrage pour verre 6mm

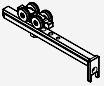

**Set for 1 glass door up to 36 kg (79 lbs.), with height adjustment**

	No.
Hawa Clipo 36 GPPK, for 1 door	053.3361.072

**Set consisting of:**

		053.3361.072	No.
	Running gear	2	053.3344.071
	Flat countersunk head chipboard screw, 3x12 mm (1/8" x 15/32"), steel, zinc-plated, black	5	600.0000.703
	Stopper, plastic, gray	2	057.3148.071
	Centring help, for 6 mm (1/4") glass	8	053.3139.001
	End cover	3	053.0329.001
	Bottom guide	1	053.0333.001
	Flat countersunk head chipboard screw 2.5x20 mm (1/8" x 25/32"), steel, zinc-plated	2	600.0000.705

**Suspension and glass retaining profiles**

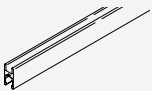
		mm (inch)	No.
	Glass fixing profile, aluminum, anodized	2,500 (8' 2 7/16")	053.3072.250
		3,500 (11' 5 25/32")	053.3072.350
		6,000 (19' 8 7/32")	053.3072.600

**Adhesive**

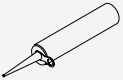
	No.
	Glue Ceresit 3B Silicone, 310 ml
	098.0027.000

**Running tracks**

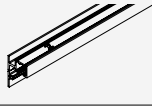
		mm (inch)	No.
	Single running track, with panel, for screw fixing, aluminum, anodized	2,500 (8' 2 7/16")	053.3338.250

**Fixed glass support profiles**

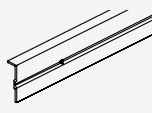
		mm (inch)	No.
	Fixed glass support profile, aluminum, anodized, pre-drilled	2,500 (8' 2 7/16")	053.3071.250

**Panels**

		mm (inch)	No.
	Panel, aluminum, anodized (use double-sided adhesive tape)	2,500 (8' 2 7/16")	053.3075.250

**Soft close up to 15/26/36 kg (33/57/79 lbs.)**



	No.
Soft close, up to 15 kg (33 lbs.)	057.3159.071
Soft close, up to 26 kg (57 lbs.)	057.3159.072
Soft close, up to 40 kg (88 lbs.)	057.3159.073

		057.3159.071	057.3159.072	057.3159.073	No.

**Set consisting of:**

	Soft close, up to 15 kg (33 lbs.)	2			057.3156.071
	Release piece soft close	2	2	2	057.0182.101
	Thread rolling rounded head screw, M2.5x5 mm (3/32" x 3/16"), steel, zinc-plated	2	2	2	600.0000.764
	Soft close, up to 26 kg (57 lbs.)		2		057.3156.072
	Soft close, up to 40 kg (88 lbs.)			2	057.3156.073

**Handles**

		No.
	Handle, for glue fixing, 64 mm (2 17/32"), plastic, chrome-plated, matt, 2-piece set	053.3323.971
	Finger-pull-handle, for glue fixing, 30 mm (1 3/16"), aluminum, anodized, 2-piece set	053.3091.982
	Finger-pull-handle, for glue fixing, 30 mm (1 3/16"), aluminum, anodized, 50-piece set	053.3091.983
	Finger-pull-handle, for glue fixing, 40 mm (1 9/16"), aluminum, anodized	053.3158.901

**Screw set**

		No.
Fixing screws to fix glass profile Hawa Clipo 36, 50-piece set		098.0007.101

		098.0007.101	No.
<b>Set consisting of:</b>			
	Thread rolling rounded head screw, M3x8 mm (1/8"x5/16"), steel, zinc-plated	50	762.7007.100

**Accessories**

		No.
	Track cleaner, plastic, red	040.3142.071

**Calculations**

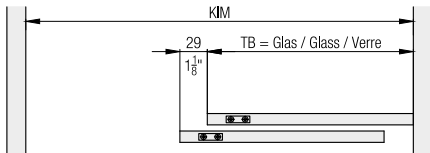
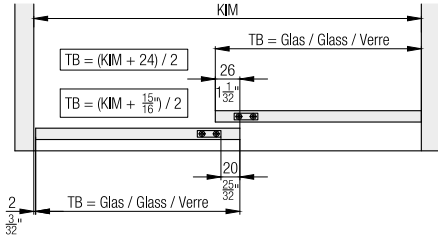

**Support and glass retaining profile attached to base**

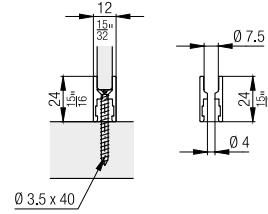

**Locking systems**

Details from page 242 onwards

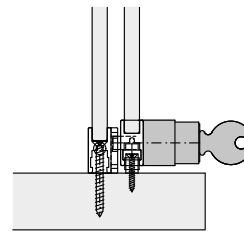

**Soft close**



	Z ≥	
	1	2
Hawa Porta 40 H	1' 4 17/32"	2' 0 13/32"
Hawa Porta 40 GE	1' 2 13/16"	1' 10 11/16"
Hawa Clipo 26 H IS	1' 4 17/32"	2' 0 13/32"
Hawa Clipo 26 H MS	1' 6 3/32"	2' 1 29/32"
Hawa Clipo 36 H IS	1' 4 17/32"	2' 0 13/32"
Hawa Clipo 36 H MS	1' 6 1/32"	2' 1 29/32"
Hawa Clipo 36 HM IS	1' 4 17/32"	2' 0 13/32"
Hawa Clipo 26 GR IS	1' 4 17/32"	2' 0 13/32"
Hawa Clipo 36 G IS	1' 4 17/32"	2' 0 13/32"
Hawa Clipo 36 GPK IS	1' 4 17/32"	2' 0 13/32"
Hawa Clipo 36 GPPK IS	1' 4 17/32"	2' 0 13/32"
Hawa Regal C 26 HM IS	1' 4 17/32"	2' 0 13/32"
Hawa Regal C 26 GR IS	1' 3 3/4"	1' 11 5/8"

	Z ≥	
	1	2
Hawa Porta 40 H	420	620
Hawa Porta 40 GE	376	576
Hawa Clipo 26 H IS	420	620
Hawa Clipo 26 H MS	458	658
Hawa Clipo 36 H IS	420	620
Hawa Clipo 36 H MS	458	658
Hawa Clipo 36 HM IS	420	620
Hawa Clipo 26 GR IS	420	620
Hawa Clipo 36 G IS	420	620
Hawa Clipo 36 GPK IS	420	620
Hawa Clipo 36 GPPK IS	420	620
Hawa Regal C 26 HM IS	420	620
Hawa Regal C 26 GR IS	400	600

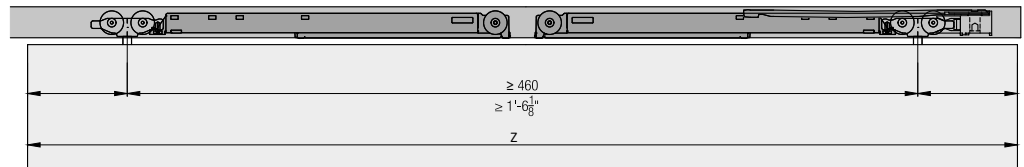
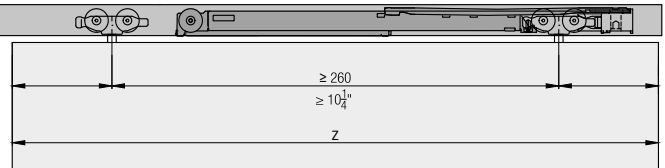

**Accessories**

- Locking systems from page 242
- Glass recommendations from page 249

**Planning/execution**

Further information about the product can be found on [www.hawa.com](http://www.hawa.com).