

DE Vorderansicht
FR Vue de face
EN Front view
IT Vista frontale
ES Vista frontal

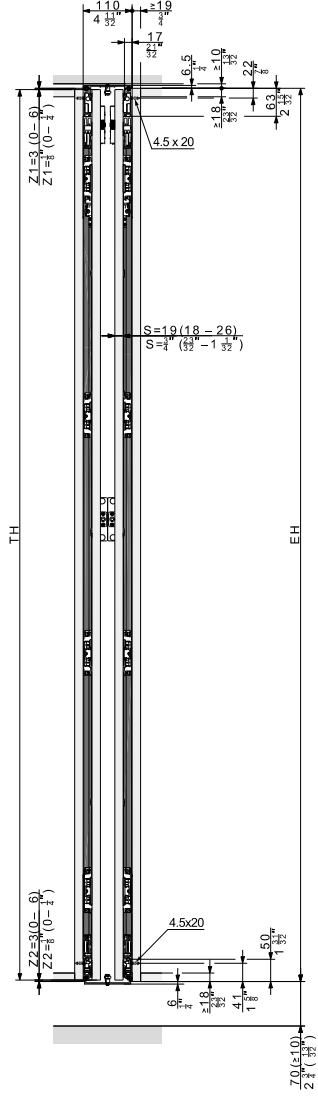

DE Ablängen der Profile
FR Raccourcir les profilés
EN Cutting the profiles to length
IT Taglio a misura dei profili
ES Cortar a medida los perfiles

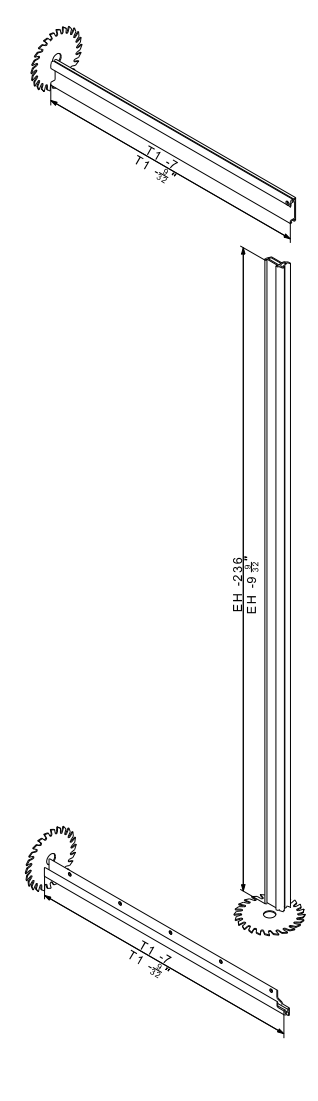

Hawa Concepta III 25/35 Push

DE Seitenansicht
FR Vue de côté
EN Side view
IT Vista laterale
ES Vista lateral

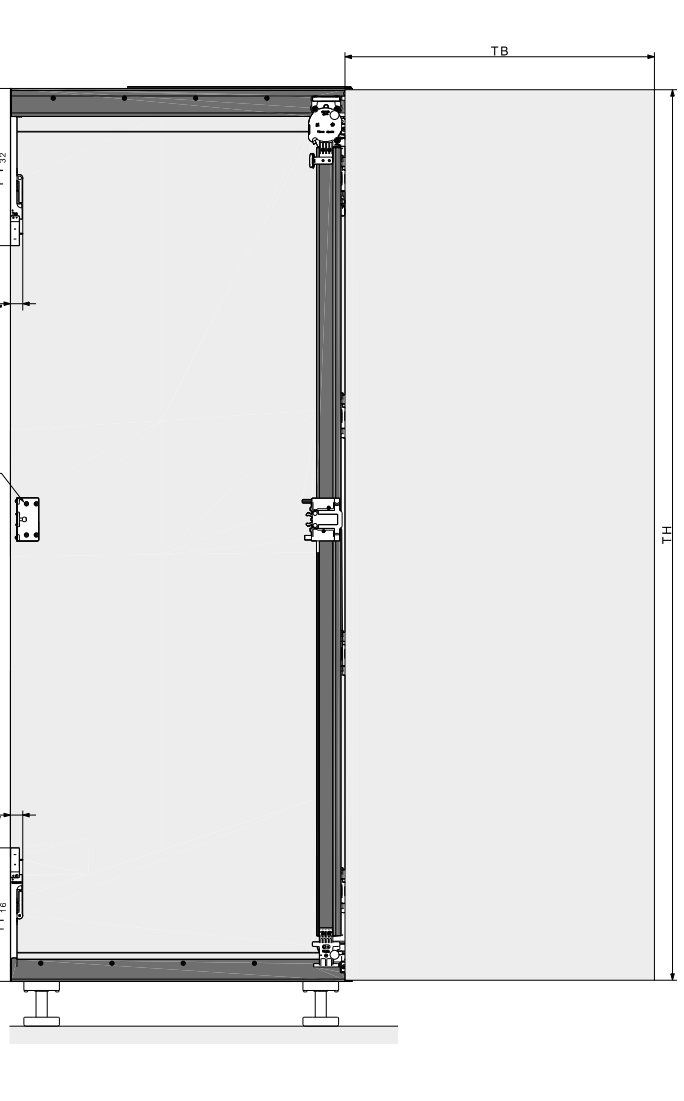

Hawa Concepta III 25/35 Pull

DE Seitenansicht
FR Vue de côté
EN Side view
IT Vista laterale
ES Vista lateral

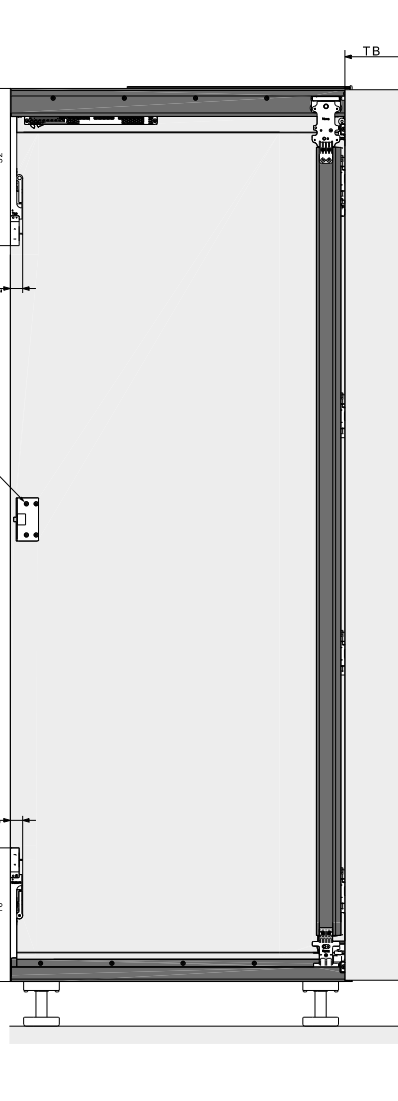

DE Beschlagseite B
FR Côté de la ferrure B
EN Fitting side B
IT Lato ferramenta B
ES Lado del herraje B

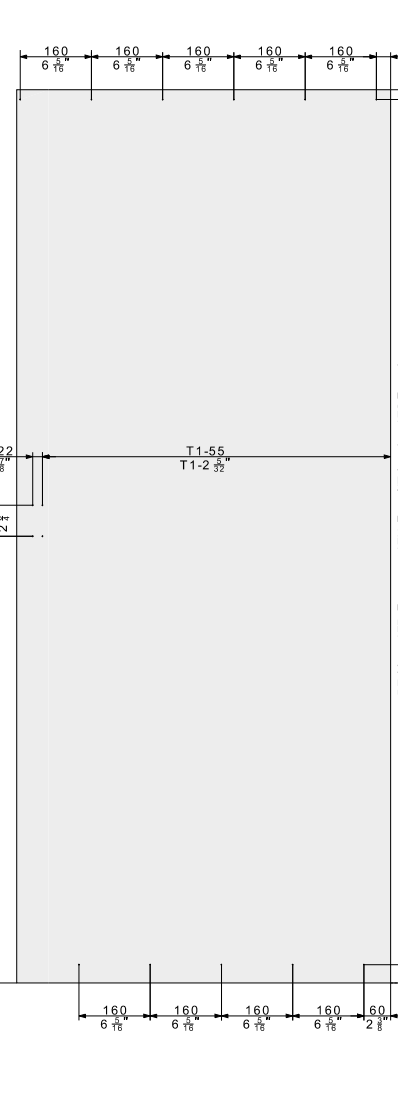

DE Türe Concepta III 35
FR Porte Concepta III 35
EN Door Concepta III 35
IT Anta Concepta III 35
ES Puerta Concepta III 35

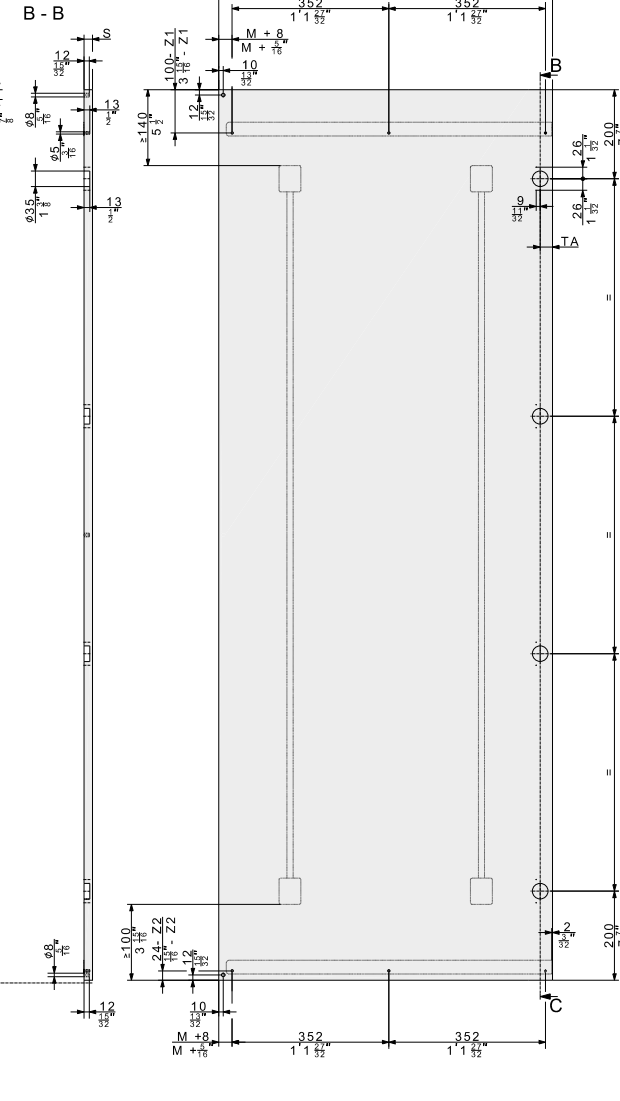

DE Türe Concepta III 25
FR Porte Concepta III 25
EN Door Concepta III 25
IT Anta Concepta III 25
ES Puerta Concepta III 25

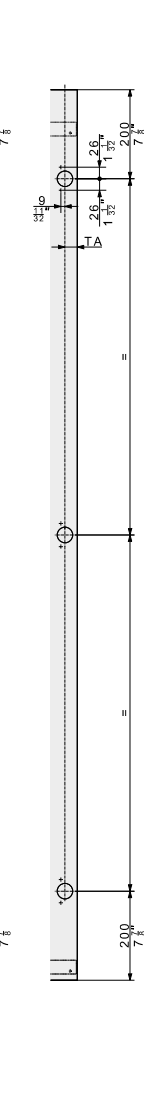

Hawa Concepta III 25/35 Push

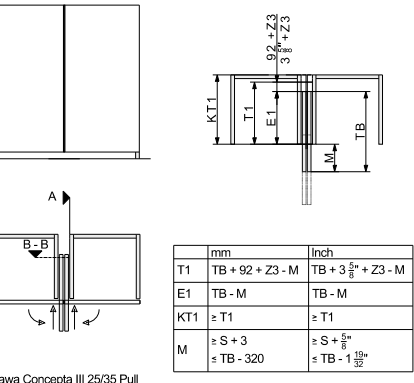

DE Türe bündig
FR Porte affleurante
EN Flush door
IT Porta complanare
ES Puerta enrasada



DE Türe vorstehend
FR Porte en saillie
EN Protruding door
IT Porta sporgente
ES Puerta saliente

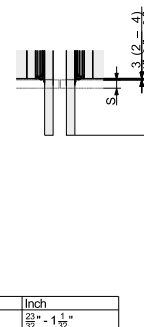

DE Draufsicht
FR Vue de dessus
EN Top view
IT Vista dall'alto
ES Vista superior

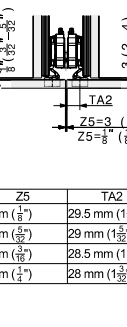

Hawa Concepta III 25

DE Maximale Gewichte in kg / FR Poids maximale en kg / EN Maximum weights in kg / IT Pesì massimo in kg / ES Pesos máximos en kg

	DE Türbreite / FR Largeur de porte / EN Door width / IT Larghezza anta / ES Ancho de puerta						
	440	500	550	600	650	700	750
2200	25	25	25	25	25	25	24
2150	25	25	25	25	25	25	23
2100	25	25	25	25	25	24	23
2050	25	25	25	25	25	24	22
2000	25	25	25	25	25	23	21
1950	25	25	25	25	24	22	21
1900	25	25	25	25	23	21	20
1850	25	25	25	24	22	21	19
1800	25	25	25	23	21	20	19
1750	25	25	25	22	21	19	18
1700	25	25	24	22	20	19	17
1650	25	25	23	21	19	18	17
1600	25	24	22	20	18	17	16
1550	25	23	21	19	18	16	15
1500	24	22	20	18	17	16	15
1450	23	21	19	17	16	15	14
1400	22	20	18	17	15	14	13
1350	21	19	17	16	15	14	13
1300	20	18	16	15	14	13	12
1250	19	17	15	14	13	12	11
1200	18	16	15	13	12	11	11

Hawa Concepta III 25

DE Maximale Gewichte in lbs. / FR Poids maximale en lbs. / EN Maximum weights in lbs. / IT Pesì massimo in lbs. / ES Pesos máximos en lbs.

	DE Türbreite / FR Largeur de porte / EN Door width / IT Larghezza anta / ES Ancho de puerta						
	440	500	550	600	650	700	750
7'2 5/8"	55	55	55	55	55	55	53
7'0 1/4"	55	55	55	55	55	55	51
6'8 1/8"	55	55	55	55	55	53	51
6'6 3/4"	55	55	55	55	55	53	49
6'4 3/8"	55	55	55	55	53	49	46
6'2 1/4"	55	55	55	55	51	46	44
6'0 1/8"	55	55	55	53	49	46	42
5'8 3/8"	55	55	55	55	49	46	42
5'6 1/8"	55	55	53	49	44	42	37
5'4 3/8"	55	55	51	46	42	40	37
5'3"	55	53	49	44	40	37	35
5'1 1/8"	55	51	46	42	40	35	33
4'9 3/8"	51	46	42	37	35	33	31
4'7 3/8"	49	44	40	37	33	31	29
4'5 5/8"	46	42	37	35	33	31	29
4'3 3/8"	44	40	35	33	31	29	26
4'1 1/8"	42	37	33	31	29	26	24
3'11 1/4"	40	35	33	29	26	24	24

Hawa Concepta III 35

DE Maximale Gewichte in kg / FR Poids maximale en kg / EN Maximum weights in kg / IT Pesì massimo in kg / ES Pesos máximos en kg

	DE Türbreite / FR Largeur de porte / EN Door width / IT Larghezza anta / ES Ancho de puerta						
	440	500	550	600	650	700	750
2700	35	35	35	35	35	35	35
2650	35	35	35	35	35	35	35
2600	35	35	35	35	35	35	35
2550	35	35	35	35	35	35	35
2500	35	35	35	35	35	35	35
2450	35	35	35	35	35	35	34
2400	35	35	35	35	35	35	33
2350	35	35	35	35	35	34	32
2300	35	35	35	35	35	34	31
2250	35	35	35	35	35	33	31
2200	35	35	35	35	34	32	30
2150	35	35	35	35	33	31	29
2100	35	35	35	35	32	30	28
2050	35	35	35	34	31	29	27
2000	35	35	35	33	30	28	26
1950	35	35	35	32	29	27	26
1900	35	35	34	31	29	27	25

Hawa Concepta III 35

DE Maximale Gewichte in lbs. / FR Poids maximale en lbs. / EN Maximum weights in lbs. / IT Pesì massimo in kg / ES Pesos máximos en lbs.

	DE Türbreite / FR Largeur de porte / EN Door width / IT Larghezza anta / ES Ancho de puerta						
	440	500	550	600	650	700	750
8'10 5/8"	77	77	77	77	77	77	77
8'8 1/8"	77	77	77	77	77	77	77
8'6 3/8"	77	77	77	77	77	77	77
8'4 3/8"	77	77	77	77	77	77	77
8'2 1/8"	77	77	77	77	77	77	77
8'0 3/8"	77	77	77	77	77	77	75
7'10 1/4"	77	77	77	77	77	77	73
7'8 1/8"	77	77	77	77	77	75	71
7'6 3/8"	77	77	77	77	77	75	68
7'4 3/8"	77	77	77	77	75	71	66
7'2 3/8"	77	77	77	77	73	68	64
7'0 1/8"	77	77	77	77	73	68	64
6'8 3/8"	77	77	77	75	68	64	62
6'6 3/4"	77	77	77	73	66	62	57
6'4 3/8"	77	77	77	71	64	60	57
6'2 1/8"	77	77	75	68	64	60	55

DE Abkürzungen / FR Abréviations / EN Abbreviations / IT Abbreviazioni / ES Abreviaturas

DE	FR	EN	IT	ES
E1	Profondeur d'encastement	Slide-in depth	Profondità di inserimento	Profundidad de introducción
EH	Hauteur d'encastement	Installation height	Altezza d'incasso	Altura de montaje
KT1	Profondeur de corps	Cabinet depth	Profondità mobile	Profundidad del mueble
M	Distance de la poignée de la porte	Door handle spacing	Sporgenza dell'anta sopra la cassa	Voladizo de la puerta por encima de la carcasa
S	Epaisseur de porte	Door thickness	Grosor de la puerta	Grosor de la puerta
T1	Profondeur de ferrure	Hardware depth	Profondità ferramenta	Profundidad del herraje
TA	Ecartement d'axe de la charnière invisible	Axis-centre distance of concealed hinge	Voladizo de la puerta por encima de la cazoleta	Distanza de la cazoleta
TB	Largeur de porte	Door width	Larghezza anta	Ancho de puerta
TH	Hauteur de porte	Door height	Altezza anta	Altura de puerta
Z	Jeu dans l'espacement	Air gap	Traffero d'aria	Espacio libre

DE Türgewicht in kg / FR Poids de porte en kg / EN Door weight in kg / IT Peso anta in kg / ES Peso de puerta en kg

DE Türgewicht in lbs. / FR Poids de porte en lbs. / EN Door weight in lbs. / IT Peso anta in lbs. / ES Peso de puerta en lbs.

DE Türgewicht in kg / FR Poids de porte en kg / EN Door weight in kg / IT Peso anta in kg / ES Peso de puerta en kg

DE Türgewicht in lbs. / FR Poids de porte en lbs. / EN Door weight in lbs. / IT Peso anta in lbs. / ES Peso de puerta en lbs.

DE Anlage links, Türe aufschlagend, zwei Türen in einer Tasche
FR Installation à gauche, Porte en applique, deux portes dans un gâlardage
EN Left-handed system, overlay door, two doors in one pocket
IT Installazione a sinistra, Anta a battuta, due porte in una cavità
ES Instalación en el lado izquierdo, Puerta sobrepuesta, dos puertas en el hueco