











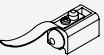

Set for 2 or 3 wooden doors

	Nr.
Hawa Combino 35 H MS, for 2 doors	056.3181.073
Hawa Combino 35 H MS, for 3 doors	056.3181.074

Set consisting of:

		056.3181.073	056.3181.074	Nr.
	Running gear, steel, zinc-plated	4	6	056.3177.171
	Running gear housing, plastic, anthracite	4	6	056.3175.001
	Guide bracket, interior door, steel, zinc-plated	2	4	055.3107.171
	Guide bracket, exterior door, steel, zinc-plated	2	2	055.3108.171
	Guide bracket housing, plastic, anthracite	4	6	053.3064.001
	Stopper, plastic, gray	2	1	056.3189.071
	Stopper, with retention spring, plastic, gray	2	3	056.3189.072
	Stopper guide, plastic, gray	4	4	040.3079.074
	Door follower, with 2 doors, steel, zinc-plated	1		055.3124.071
	Countersunk head screw, 4.5x20 mm, steel, zinc-plated	32	48	600.0000.167
	Buffer, with adhesive, 3-piece set		1	061.3083.050
	Door follower, with 3 doors, steel, zinc-plated		2	055.3126.171
	Thread-cutting rounded head screw, M4x8 mm, steel, zinc-plated		2	600.0000.328

Running tracks

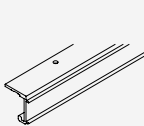
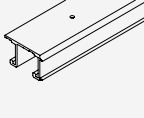
		mm (inch)	Nr.
	Single running track, aluminum, pre-drilled	2500 (8'2 7/16")	056.3011.250
		3500 (11'5 25/32")	056.3011.350
		6000 (19'8 7/32")	056.3011.600
	Double running track, aluminum, pre-drilled	2500 (8'2 7/16")	056.3010.250
		3500 (11'5 25/32")	056.3010.350
		6000 (19'8 7/32")	056.3010.600

Guide tracks

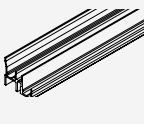



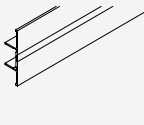

		mm (inch)	Nr.
	Double guide track, aluminum, anodized, pre-drilled	2500 (8'2 7/16")	056.3072.250
		3500 (11'5 25/32")	056.3072.350
		6000 (19'8 7/32")	056.3072.600

Panels

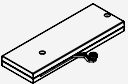
		mm (inch)	Nr.
	Clip-on panel, aluminum, anodized	2500 (8'2 7/16")	056.3174.250
		3500 (11'5 25/32")	056.3174.350
		6000 (19'8 7/32")	056.3174.600





Soft close (only for system with 2 doors)
Adapter soft close must be ordered separately

	Nr.
Soft close, 18–40 kg (40–88 lbs.), with wide follower, 2 pieces	055.3091.073

Set consisting of:		055.3091.073	Nr.
	Soft close, left, 18–40 kg (40–88 lbs.)	1	055.3090.073
	Soft close, right, 18–40 kg (40–88 lbs.)	1	055.3090.074
	Follower, for soft close, right, plastic, gray	1	055.3040.071
	Follower, for soft close, left, plastic, gray	1	055.3040.072
	Fillister head screw, 4x16 mm, steel, zinc-plated	6	600.0000.166
	Countersunk head screw, 4x30 mm, steel, zinc-plated	4	600.0000.439

Adapter soft close for No. 055.3091.073

	Nr.
Adapter set, for soft close	055.3043.073

Set consisting of:		055.3043.073	Nr.
	Adapter, for soft close, exterior door, steel, zinc-plated	1	055.0133.101
	Adapter, for soft close, interior door, steel, zinc-plated	1	055.0128.101
	Rounded head screw, M4x8 mm, steel, zinc-plated	6	759.0408.108
	Fillister head screw, 4x16 mm, steel, zinc-plated	8	600.0000.166
	Rubber buffer, plastic, grey	1	025.0107.001

Accessories

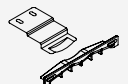
	Nr.	
	Clip-on component, for wooden panel, every 500 mm (1'7 11/16"), aluminum, pre-drilled	056.3039.001
	Intermediate stop set, for 3 doors	056.3035.071

Calculations

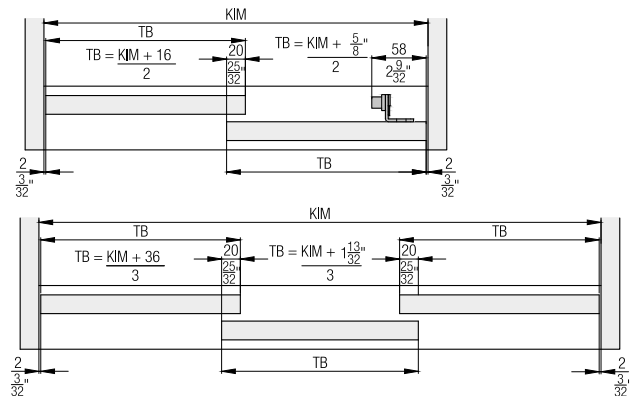

Optional: Installation with wooden panel

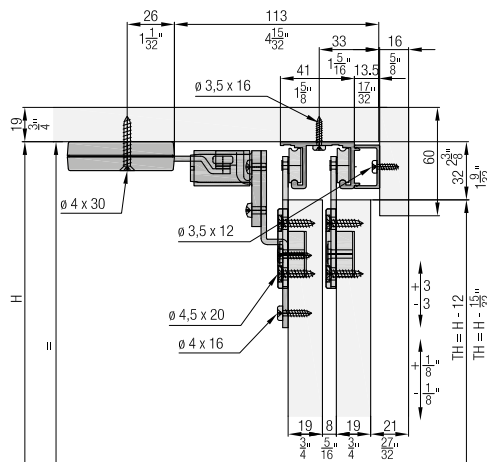

Intermediate stop with 3 doors

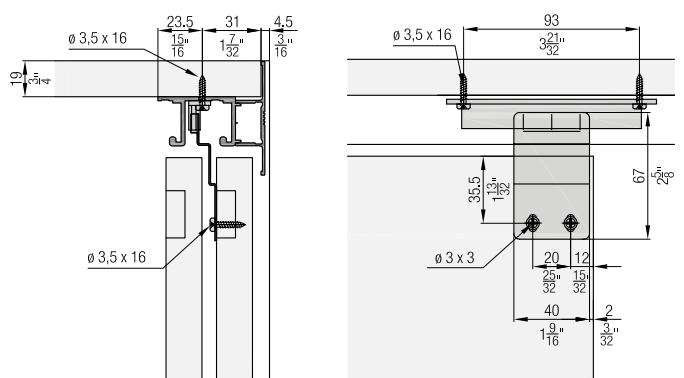

Soft close (only for system with 2 doors)

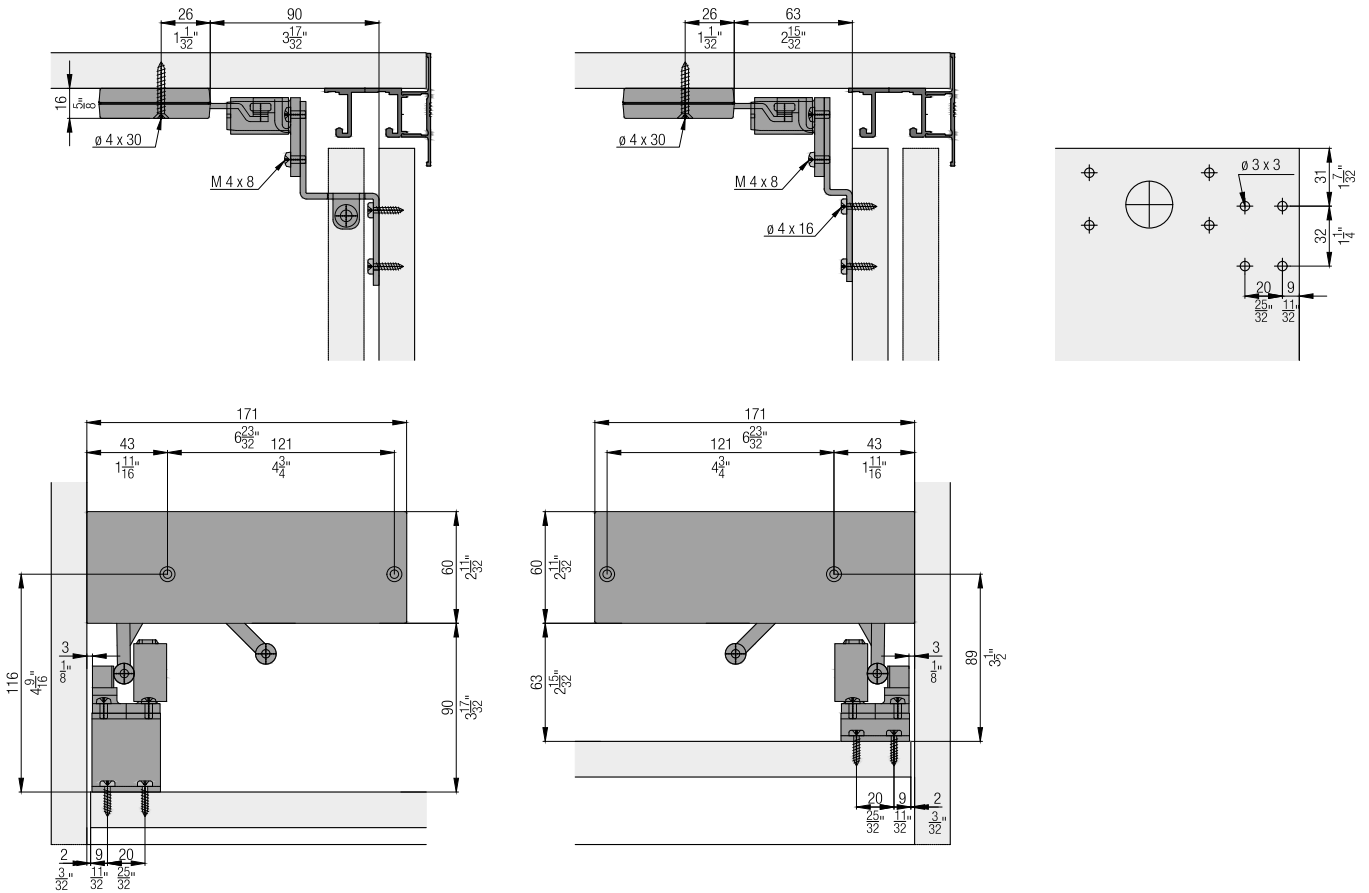

Accessories

- Straightening fitting from page 266
- Handle profiles from page 268
- Order overview soft close from page 270

Planning/execution

Further information about the product can be found on www.hawa.com.