

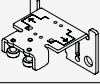

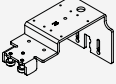





**Set for 2 or 3 wooden doors**

	No.
Hawa Combino 65 H FS ul, for 2 doors	055.3204.071
Hawa Combino 65 H FS ul, max. door width 1350 mm (4'5 5/32"), for 3 doors	055.3204.072

**Set consisting of:**

		055.3204.071	055.3204.072	No.
	Running gear, interior door, steel, zinc-plated	2	4	055.3147.071
	Running gear, exterior door, steel, zinc-plated	2	2	055.3146.071
	Guide bracket, interior door, steel, zinc-plated	2	4	055.3136.071
	Guide bracket, exterior door, 25 mm (31/32"), steel, zinc-plated	2	2	055.3137.071
	Guide bracket housing, plastic, anthracite	4	6	055.0237.001
	Stopper, plastic, gray	4	4	055.3145.071
	Retention spring for stopper, plastic, gray	2	3	055.0267.001
	Stopper guide, plastic, gray	4	4	055.3135.071
	Door follower, with soft close, plastic, gray	1	2	055.0268.001
	Activator, for door follower, steel, zinc-plated	1	2	055.0238.101
	Panel clip, plastic, gray	10	15	055.3071.001
	Centering disk, plastic, white	16	24	055.0110.001
	Countersunk head screw, 4.5x25 mm, steel, zinc-plated	32	48	766.5045.125
	Countersunk head screw, 3x10 mm, steel, zinc-plated	10	15	600.0000.395
	Thread-cutting rounded head screw, M4x6 mm, steel, zinc-plated	1	2	762.7009.107
	Thread-cutting countersunk head screw, M3x6 mm, steel, zinc-plated	2	4	600.0000.789
	Buffer, with adhesive, 2-piece set	1		053.3364.051

**Track sets**

	No.
Hawa Combino 65/80 H FS ul, 2500 mm (8'2 7/16")	055.3210.071
Hawa Combino 65/80 H FS ul, 4000 mm (13'1 15/32")	055.3210.072

**Set consisting of:**



		mm (inch)	055.3210.071	055.3210.072	No.
	Double running track, aluminum, anodized, pre-drilled	2500 (8'2 7/16")	1		055.3142.250
	Double guide track, aluminum, anodized, pre-drilled	2500 (8'2 7/16")	1		055.3134.250
	Panel profile cover, aluminum, anodized	1300 (4'3 3/16")	1		055.3170.130
	Double running track, aluminum, anodized, pre-drilled	4000 (13'1 15/32")		1	055.3142.400
	Double guide track, aluminum, anodized, pre-drilled	4000 (13'1 15/32")		1	055.3134.400
	Panel profile cover, aluminum, anodized	1600 (5'3")		1	055.3170.160

**Soft close**

For soft closing in opening and closing direction  
order 2 sets.

	No.
Hawa Combino 65 H FS, up to 65 kg (143 lbs.), 2 pieces	055.3212.071







**Set consisting of:**

		055.3212.071	No.
	Soft close, right, up to 65 kg (143 lbs.)	1	055.3138.073
	Soft close, left, up to 65 kg (143 lbs.)	1	055.3138.074
	Activator, for soft close	2	055.3157.071
	Thread-cutting rounded head screw, M5x16 mm, steel, zinc-plated	2	600.0000.591
	Thread-cutting countersunk head screw, M5x10 mm, steel, zinc-plated	2	600.0000.345

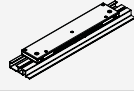
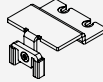
**Soft close center door**

	No.
Hawa Combino 65/80 H FS, center door	055.3217.071

	055.3217.071	No.
<b>Set consisting of:</b>		

	Soft close, center door	1	055.3193.071
	Activator, for soft close center door	1	055.3196.071
	Safety device for guide bracket, plastic, anthracite	1	053.3099.001
	Rubber buffer, plastic, transparent	2	055.0318.001
	Thread-cutting rounded head screw, M4x8 mm, steel, zinc-plated	2	762.7009.100
	Fillister head screw, 4x16 mm, steel, zinc-plated	2	600.0000.166
	Countersunk head screw, 4.5x20 mm, steel, zinc-plated	1	600.0000.167

**Accessories**

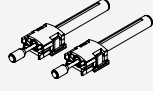
	No.	
	Soft close for guide (recommen- ded from a door ratio bigger than 1:3. Can only be used with a soft close.)	055.3219.051

**Calculations**

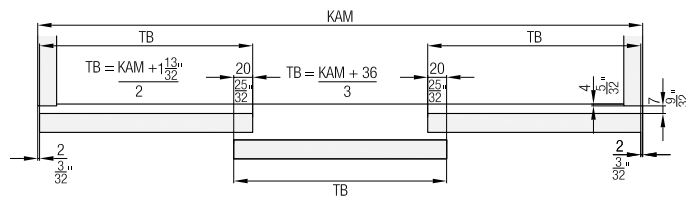
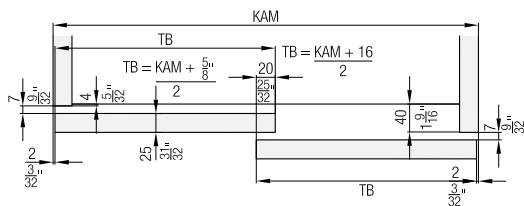

**Optional: Guide track installation from below**

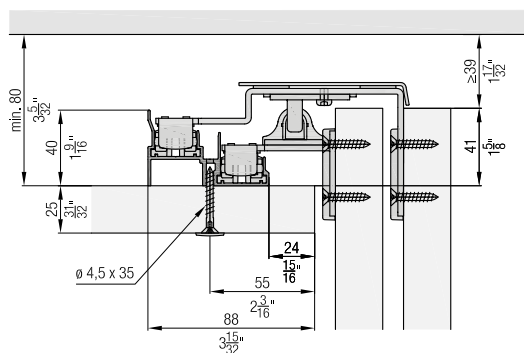

**Handle profiles**

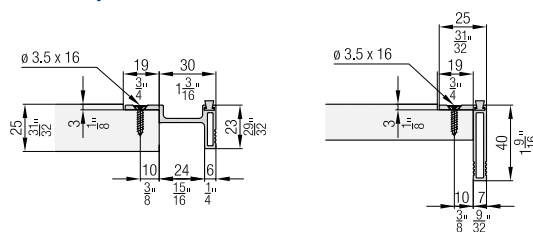

**Soft close**

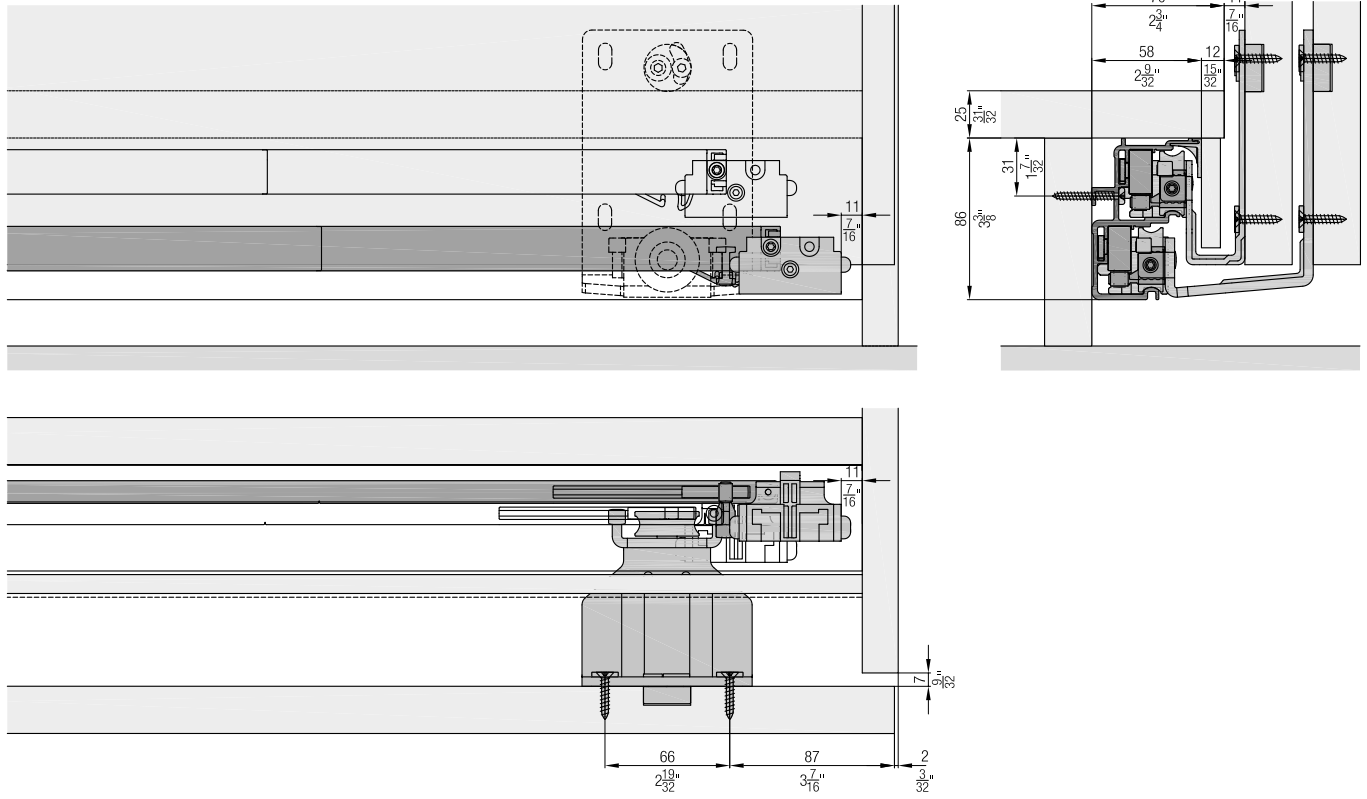

**Soft close center door**

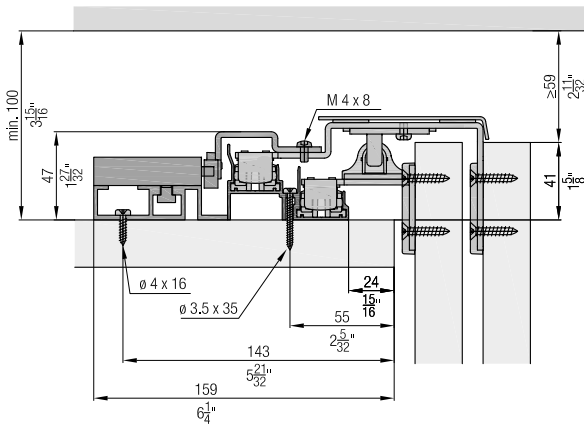

**Accessories**

- Straightening fitting from page 266
- Handle profiles from page 268
- Order overview soft close from page 270

**Planning/execution**

Further information about the product can be found on [www.hawa.com](http://www.hawa.com).