







**Fitting for 2–3 top-running wooden doors up to 65 kg (143 lbs.) with screwed on running track. Optional soft close integrated in track. Design Inside top-running**

**Product highlights**

-  **Comfort** Smooth, silent running with Hawa Comfort roller
-  **Comfort** Sophisticated soft closing system and innovation arrangement of the components for very easy operation

**Technical specifications**

-  Max. 65 kg (143 lbs.)
-  Max. 2600 mm (8'6 3/8")
-  Max. 1400 mm (4'7 1/8")
-  Min. 25–40 mm (31/32" to 1 9/16")

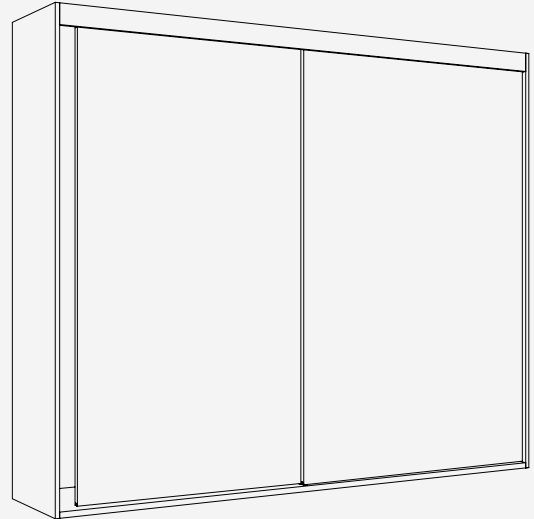



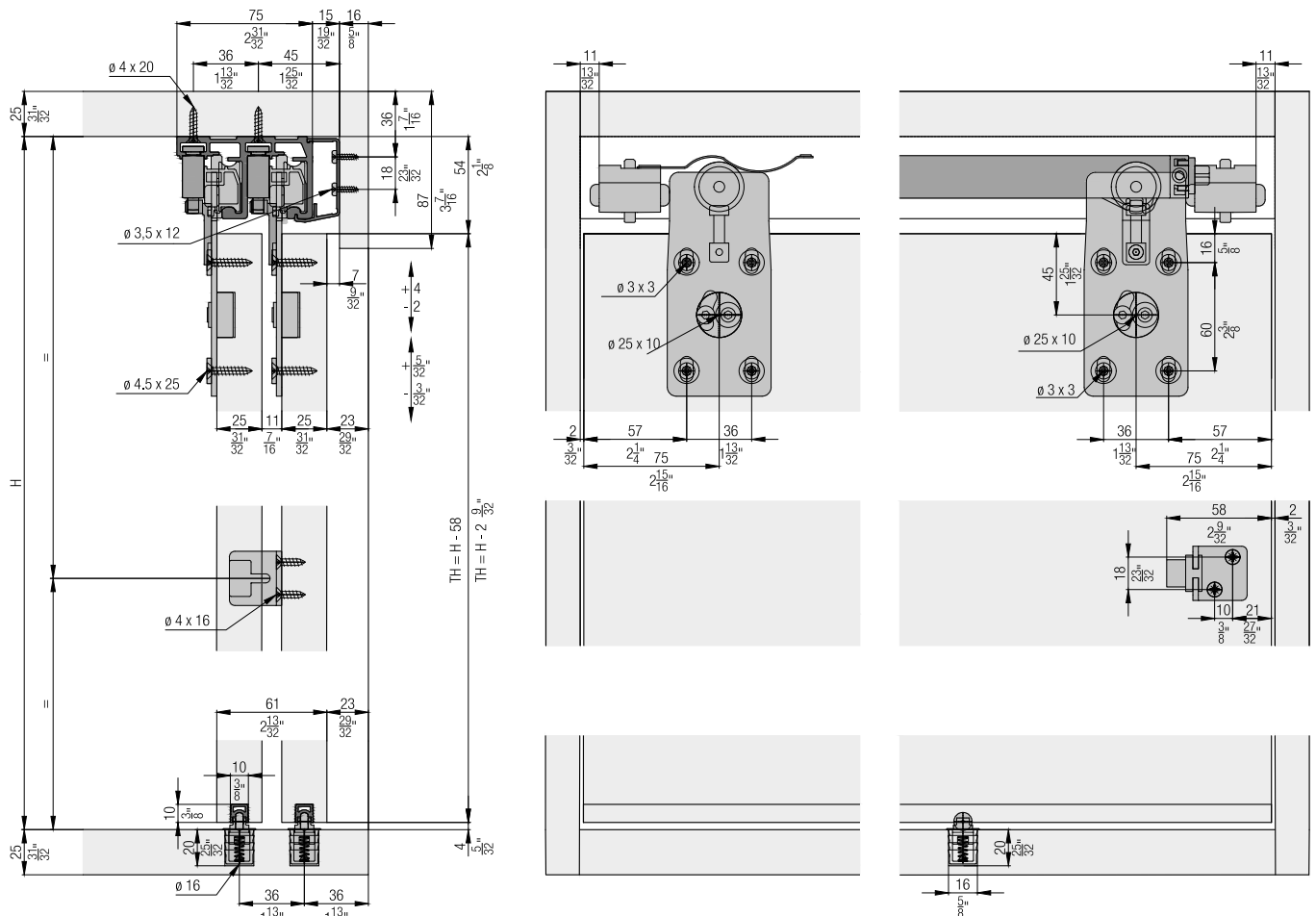





**Installation examples**



**Set for 2 or 3 wooden doors**

	Nr.
Hawa Combino 65 H IS, door thickness 25–40 mm (31/32"-1 9/16"), for 2 doors	055.3202.071
Hawa Combino 65 H IS, door thickness 25–40 mm (31/32"-1 9/16"), max. door width 1350 mm (4'5 5/32"), for 3 doors	055.3202.072

**Set consisting of:**

	055.3202.071	055.3202.072	Nr.
 Running gear, steel, zinc-plated	4	6	055.3152.071
 Bottom guide, plastic, gray	2	3	055.3081.071
 Stopper, plastic, gray	4	4	055.3153.071
 Retention spring for stopper, steel	2	3	055.3190.071
 Door follower, with 2 doors, steel, zinc-plated	1		055.3124.071
 Centering disk, plastic, white	16	24	055.0110.001
 Countersunk head screw, 4.5x25 mm, steel, zinc-plated	16	24	766.5045.125
 Thread-cutting rounded head screw, M4x8 mm, steel, zinc-plated	2	3	762.7009.100
 Buffer, with adhesive, 2-piece set	1		053.3364.051

**Track sets, 25 mm (31/32")**

	Nr.
Hawa Combino 65 H IS, 2500 mm (8'2 7/16")	055.3208.071
Hawa Combino 65 H IS, 4000 mm (13'1 15/32")	055.3208.072

**Set consisting of:**

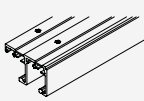
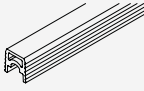
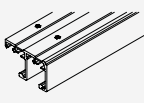
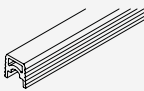
	mm (inch)	055.3208.071	055.3208.072	Nr.
 Double running track, aluminum, anodized, pre-drilled	2500 (8'2 7/16")	1		055.3143.250
 Guide track, plastic, gray, for glue fixing	2500 (8'2 7/16")	1		055.3171.250
 Double running track, aluminum, anodized, pre-drilled	4000 (13'1 15/32")		1	055.3143.400
 Guide track, plastic, gray, for glue fixing	1450 (4'9 3/32")		3	055.3171.145

**Running tracks, from a door thickness of 28 mm (1 3/32")**

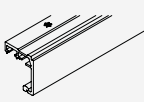
	mm (inch)	Nr.
 Single running track, aluminum, anodized, pre-drilled	2500 (8'2 7/16")	055.3162.250
	4000 (13'1 15/32")	055.3162.400

**Guide tracks**

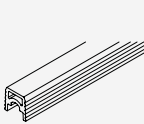



	mm (inch)	Nr.
 Guide track, plastic, gray, for glue fixing	2500 (8'2 7/16")	055.3171.250
	3500 (11'5 25/32")	055.3171.350
	6000 (19'8 7/32")	055.3171.600

**Soft close**  
**For soft closing in opening and closing direction**  
**order 2 sets.**



	Nr.
EKU Combino 65 H IS/MS, up to 65 kg (143 lbs.), 2 pieces	055.3214.071

	Nr.	055.3214.071
--	-----	--------------

**Set consisting of:**

	Soft close, right, up to 65 kg (143 lbs.)	1	055.3149.071
	Soft close, left, up to 65 kg (143 lbs.)	1	055.3149.072
	Activator, for soft close	2	055.3156.071
	Thread-cutting head screw, M4x8 mm, steel, zinc-plated	2	600.0000.344

**Accessories**

	Nr.	
	Door centering, for 2 doors, plastic, anthracite	053.3207.071
	Clip-on component, for wooden panel, every 700–800 mm (2'3 9/16"–2'7 1/2"), aluminum, pre-drilled	055.3155.000

**Door 40 mm (1 9/16")**

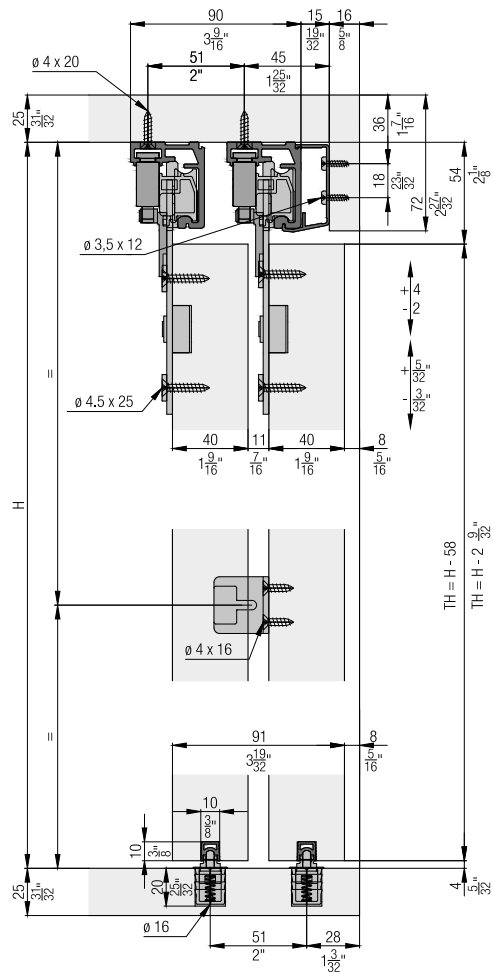

**Calculations**

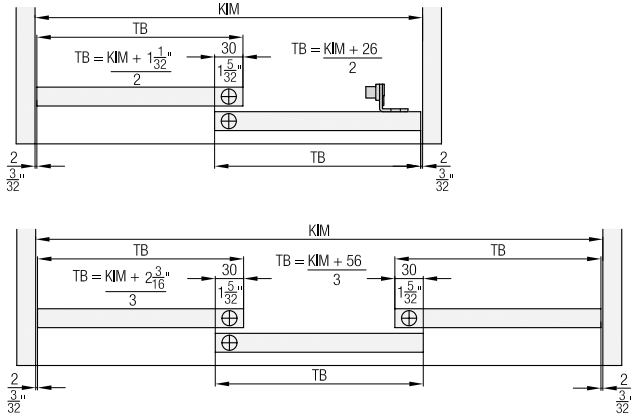

**Door centering**

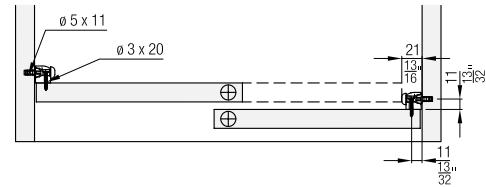

**Soft close**

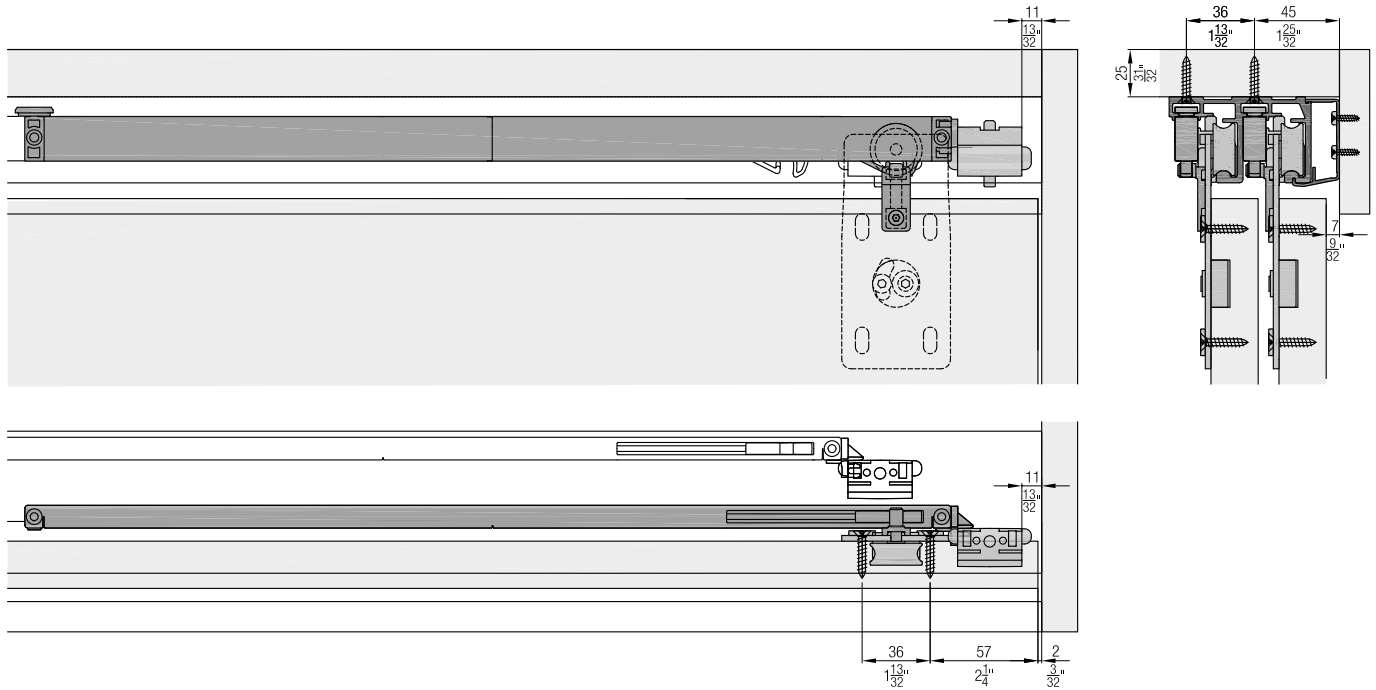

**Accessories**

- Straightening fitting from page 266
- Order overview soft close from page 270

**Planning/execution**

Further information about the product can be found on [www.hawa.com](http://www.hawa.com).