

Set for 2 or 3 wooden doors

	No.
Hawa Combino 65 H FS ol, door thickness 19–40 mm (3/4"-1 9/16"), for 2 doors	055.3205.071
Hawa Combino 65 H FS ol, door thickness 19–40 mm (3/4"-1 9/16"), max. door width 1350 mm (4'5 5/32"), for 3 doors	055.3205.072





Set consisting of:

	055.3205.071	055.3205.072	No.
 Running gear, interior door, aluminum, anodized	2	4	055.3150.071
 Running gear bracket, exterior door, steel, zinc-plated	2	2	055.3159.071
 Running gear, exterior door, aluminum, anodized	2	2	055.3158.071
 Anti-derailment device, plastic, red	4	6	055.0279.001
 Guide bracket, interior door, aluminum, anodized	2	4	055.3178.071
 Guide bracket, exterior door, aluminum, anodized	2	2	055.3179.071
 Guide plate, plastic, gray	4	6	055.0269.001
 Stopper, left, plastic, gray	2	2	055.3163.071
 Stopper, right, plastic, gray	2	2	055.3163.072
 Stopper guide, plastic, gray	4	4	055.3135.071
 Door follower, with soft close, plastic, gray	1	2	055.0268.001
 Activator, for door follower, steel, zinc-plated	1	2	055.0259.101
 Rounded head screw, M5x16 mm, steel, zinc-plated	4	4	600.0000.782
 Countersunk head screw, 5x20 mm, steel, zinc-plated	42	62	600.0000.787
 Thread-cutting rounded head screw, M4x8 mm, steel, zinc-plated	1	2	762.7009.100
 Thread-cutting head screw, M4x8 mm, steel, zinc-plated	4	6	600.0000.344
 Thread-cutting countersunk head screw, M3x6 mm, steel, zinc-plated	2	4	600.0000.789
 Buffer, with adhesive, 2-piece set	1		053.3364.051

Track sets

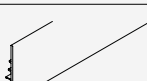
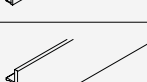
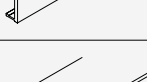
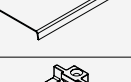
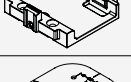
	No.
Hawa Combino 65/80 H FS ol, 2500 mm (8'2 7/16")	055.3211.071
Hawa Combino 65/80 H FS ol, 4000 mm (13'1 15/32")	055.3211.072

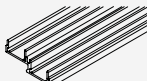
Set consisting of:

	mm (inch)	055.3211.071	055.3211.072	No.
 Double running track, aluminum, anodized	2500 (8'2 7/16")	1		055.3183.250
 Double guide track, aluminum, anodized	2500 (8'2 7/16")	1		055.3184.250
 Panel profile running track, aluminum, anodized	2500 (8'2 7/16")	1		055.3181.250
 Panel profile guide track, aluminum, anodized	2500 (8'2 7/16")	1		055.3182.250
 Panel profile cover, aluminum, anodized	1300 (4'3 3/16")	1		055.3170.130
 Fixing adapter, zinc-plated		15	20	055.3180.071
 Drilling jig, plastic, anthracite		1	1	055.0316.001
 Countersunk head screw, 4x25 mm, steel, zinc-plated		60	80	766.5042.125
 Double running track, aluminum, anodized	4000 (13'1 15/32")		1	055.3183.400
 Double guide track, aluminum, anodized	4000 (13'1 15/32")		1	055.3184.400
 Panel profile running track, aluminum, anodized	4000 (13'1 15/32")		1	055.3181.400
 Panel profile guide track, aluminum, anodized	4000 (13'1 15/32")		1	055.3182.400
 Panel profile cover, aluminum, anodized	1600 (5'3")		1	055.3170.160

Reinforcement profile

		mm (inch)	No.
	Reinforcement profile, aluminum, anodized, pre-drilled, recommended from a span width of 800 mm (2'7 1/2")	2500 (8'2 7/16")	055.3185.250
		4000 (13'1 15/32")	055.3185.400

Soft close

For soft closing in opening and closing direction order 2 sets.

		No.
Hawa Combinio 65 H FS ol, up to 65 kg (143 lbs.), 2 pieces		055.3206.071





Set consisting of:

	Soft close, right, up to 65 kg (143 lbs.)	1	055.3187.074
	Soft close, left, up to 65 kg (143 lbs.)	1	055.3187.073
	Activator, for soft close, plastic, gray	2	055.3186.071
	Thread-cutting rounded head screw, M4x20 mm, steel, zinc-plated	2	600.0000.783
	Thread-cutting countersunk head screw, M4x10 mm, steel, zinc-plated	2	600.0000.778

Soft close center door

		No.
Hawa Combinio 65/80 H FS ol, center door		055.3207.071

Set consisting of:

	Soft close, center door	1	055.3197.071
	Activator, for soft close center door	1	055.3198.071
	Rubber buffer, plastic, transparent	2	055.0318.001
	Thread-cutting rounded head screw, M4x10 mm, steel, zinc-plated	1	600.0000.790

Accessories

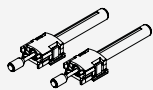
		No.	
	Soft close for guide (recommended from a door ratio bigger than 1:3. Can only be used with a soft close.)		055.3219.051

Calculations

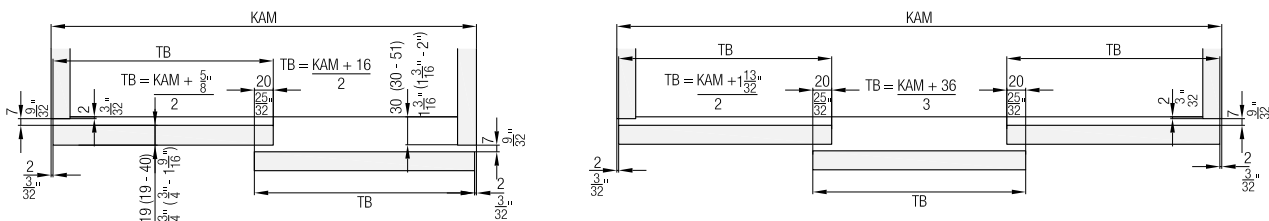

Handle profiles

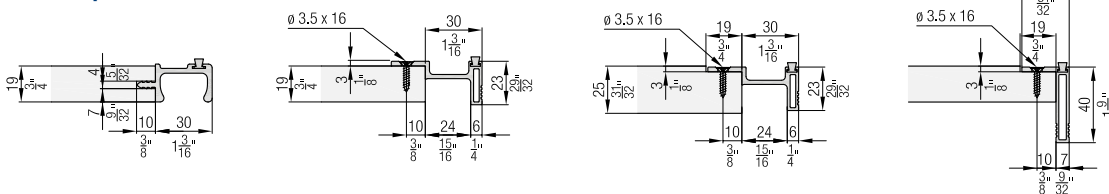

Soft close

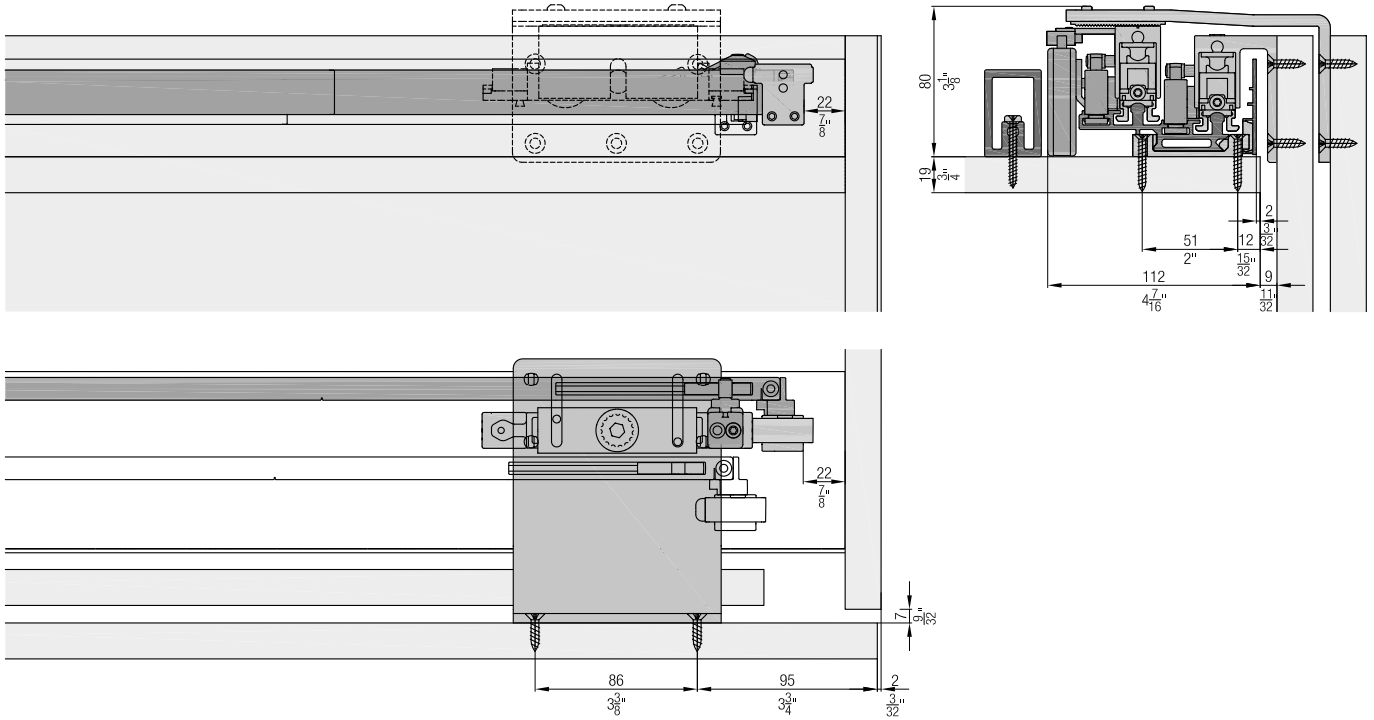

Soft close center door

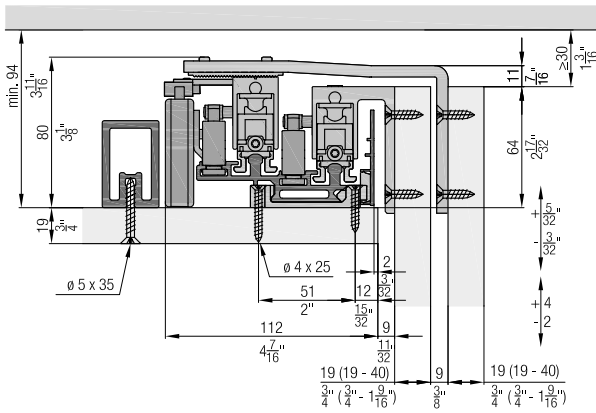

Accessories

- Straightening fitting from page 266
- Handle profiles from page 268
- Order overview soft close from page 270

Planning/execution

Further information about the product can be found on www.hawa.com.