

DE Vorderansicht
FR Vue de face
EN Front view
IT Vista frontale
ES Vista frontal

DE Ablängen der Profile
FR Raccourcir les profils
EN Cutting the profiles to length
IT Taglio a misura dei profili
ES Cortar a medida los perfiles

Hawa Folding Concepta III 25 Push

DE Seitenansicht
FR Vue de côté
EN Side view
IT Vista laterale
ES Vista lateral

Hawa Concepta III 35 Push

DE Seitenansicht
FR Vue de côté
EN Side view
IT Vista laterale
ES Vista lateral

DE Ablängen der Profile
FR Raccourcir les profils
EN Cutting the profiles to length
IT Taglio a misura dei profili
ES Cortar a medida los perfiles

DE Vorderansicht
FR Vue de face
EN Front view
IT Vista frontale
ES Vista frontal

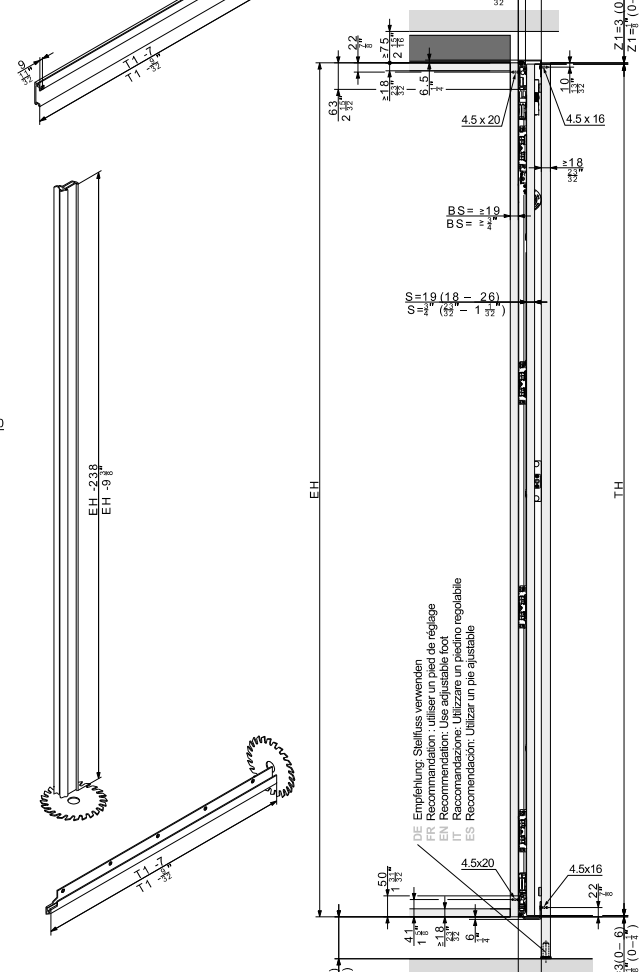
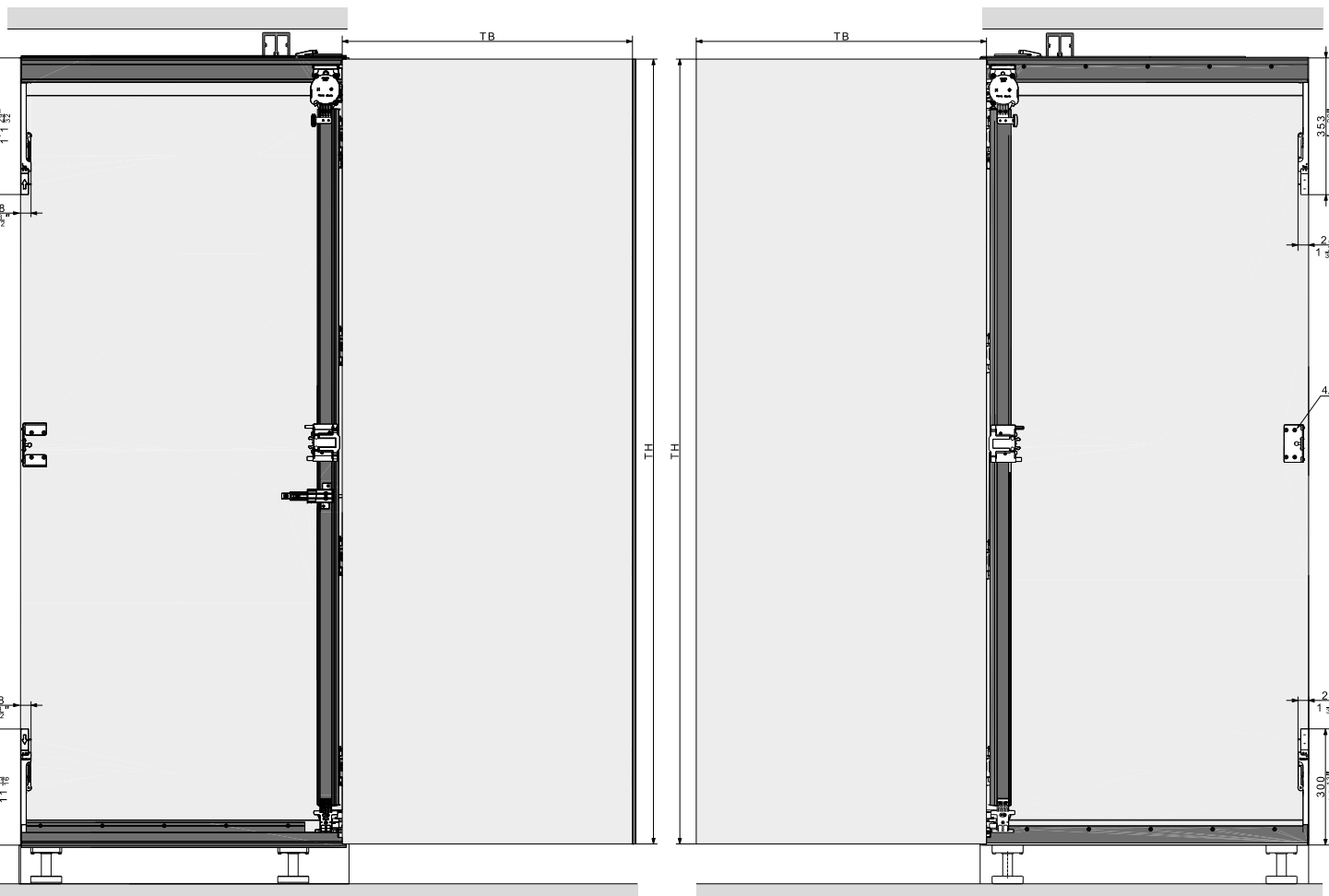
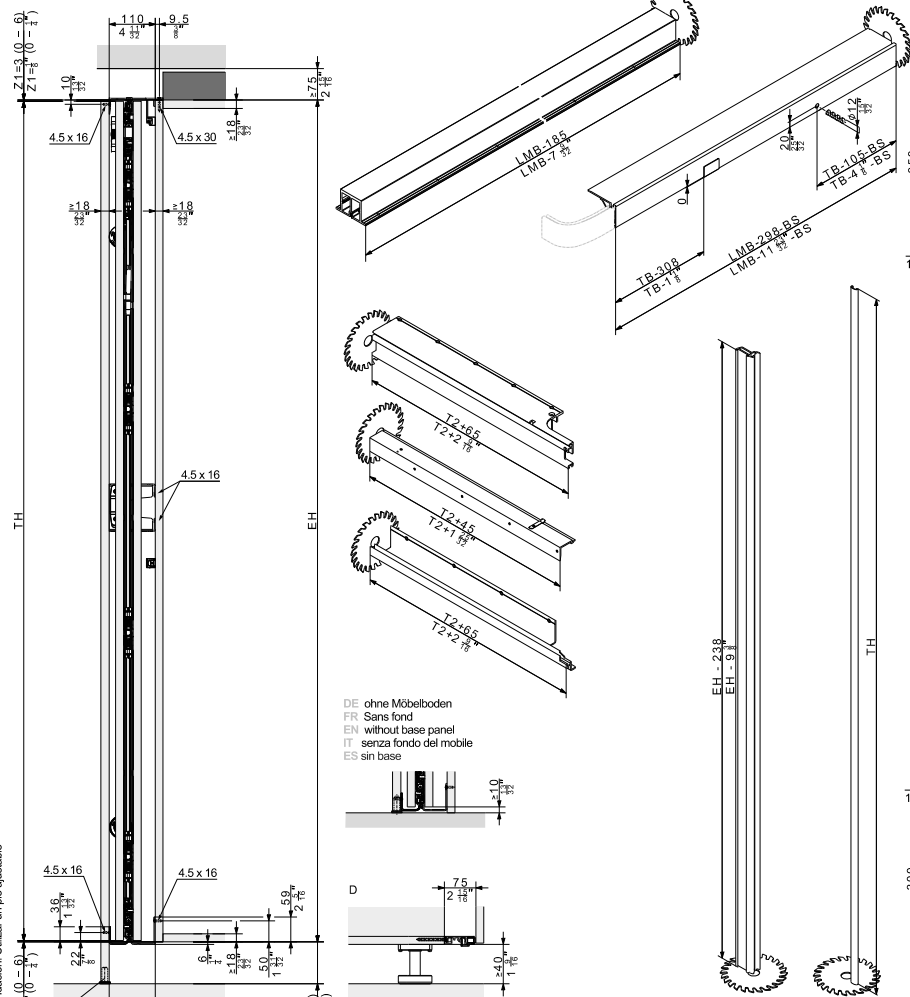

DE ohne Möbelboden
FR Sans fond
EN without base panel
IT senza fondo del mobile
ES sin base

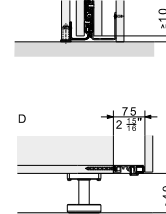

DE mit Bodenprofil, siehe Beipackblatt 52036
FR Avec profil de fond inférieur, voir le mode d'emploi joint 52036
EN with base profile, see leaflet 52036
IT con profilo a pavimento, vedere manuale di istruzioni 52036
ES con perfil para la base: ver hoja de instrucciones 52036

DE Verstärkungsprofil
FR Profil de renforcement
EN Reinforcement profile
IT Profilo di rinforzo
ES Perfil de refuerzo

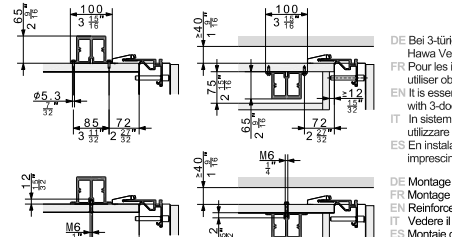

DE Bei 3-türigen Anlagen ohne Mittelwände zwingend das Hawa Verstärkungsprofil 24322 verwenden.
FR Pour les installations à 3 portes sans parois centrales, utiliser obligatoirement le profil de renforcement Hawa 24322.
EN It is essential to use the Hawa reinforcement profile 24322 with 3-door systems without separating walls.
IT In sistemi a 4 ante senza pareti centrali è obbligatorio utilizzare il profilo di rinforzo Hawa 24322.
ES En instalaciones de 4 puertas sin paredes central es imprescindible utilizar el perfil de refuerzo Hawa 24322.

DE Montage Verstärkungsprofil siehe Beipackblatt 52064
FR Montage profil de renforcement voir le mode d'emploi joint 52064
EN Reinforcement profile installation see leaflet 52064
IT Vedere il montaggio del profilo di rinforzo nel manuale di istruzioni 52064
ES Montaje del perfil de refuerzo: ver hoja de instrucciones 52064

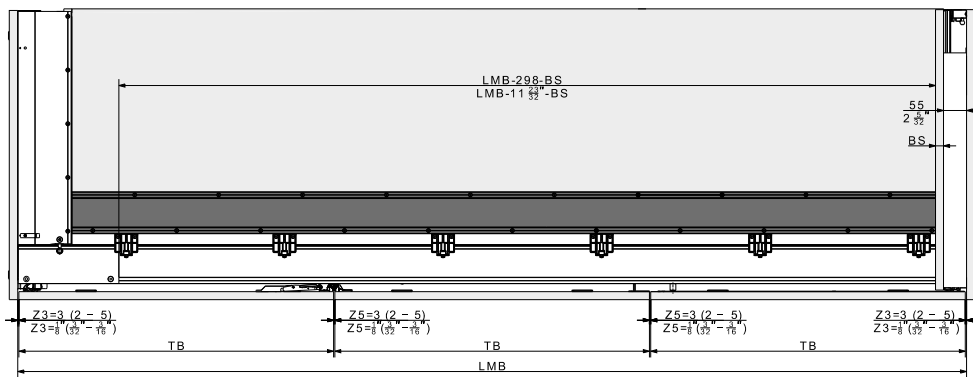

DE Draufsicht
FR Vue de dessus
EN Top view
IT Vista dall'alto
ES Vista superior

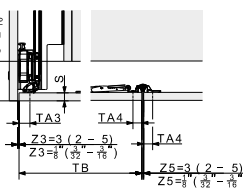

DE Draufsicht
FR Vue de dessus
EN Top view
IT Vista dall'alto
ES Vista superior

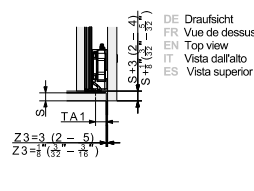

DE Türe vorstehend
FR Porte en saillie
EN Protruding door
IT Porta sporgente
ES Puerta saliente

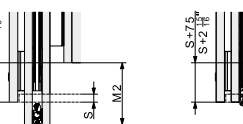

DE Türe bündig
FR Porte affleurante
EN Flush door
IT Porta complanare
ES Puerta enrasada

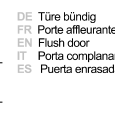

DE Türe bündig
FR Porte affleurante
EN Flush door
IT Porta complanare
ES Puerta enrasada

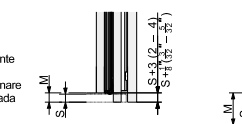

DE Türe vorstehend
FR Porte en saillie
EN Protruding door
IT Porta sporgente
ES Puerta saliente

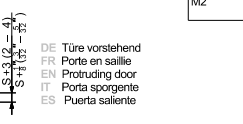

	Hawa Folding Concepta III	Hawa Concepta III
DE Masse FR Dimensions EN Dimensions IT Dimensioni ES Medidas	mm	mm
BS	± 19	± 19
S	18 - 26	18 - 26
T1	± 414	± 414
T2	± 344	± 344
TB	440 - 750	440 - 750
TH	1200 - 2700	1200 - 2700
Z1	0 - 6	0 - 6
Z2	0 - 6	0 - 6
Z3	2 - 5	2 - 5
Z5	2 - 5	2 - 5
DE Formeln FR Formulas EN Formulas IT Formule ES Fórmulas	mm	mm
T1	TB + 92 + Z3 - M2	TB + 92 + Z3 - M
E1	TB - M	TB - M
E2	TB - M2	TB - M2
KT1	± T1	± T1
KT2	± T2	± T2
M	± S + 75	± TB - 320
M2	± S + 75	± TB - 390

	Hawa Folding Concepta III	Hawa Concepta III
DE Masse FR Dimensions EN Dimensions IT Dimensioni ES Medidas	Inch	Inch
BS	± 3/4"	± 3/4"
S	9/16" - 1 1/8"	9/16" - 1 1/8"
T1	± 16 1/2"	± 16 1/2"
T2	± 13 5/8"	± 13 5/8"
TB	17 1/2" - 29 1/2"	17 1/2" - 29 1/2"
TH	3' 11 1/2" - 8' 10 1/2"	3' 11 1/2" - 8' 10 1/2"
Z1	0 - 1/4"	0 - 1/4"
Z2	0 - 1/4"	0 - 1/4"
Z3	3/8" - 5/8"	3/8" - 5/8"
Z5	3/8" - 5/8"	3/8" - 5/8"
DE Formeln FR Formulas EN Formulas IT Formule ES Fórmulas	Inch	Inch
T1	TB + 3 5/8" + Z3 - M2	TB + 3 5/8" + Z3 - M
E1	TB - M	TB - M
E2	TB - M2	TB - M2
KT1	± T1	± T1
KT2	± T2	± T2
M	± S + 2 7/8"	± TB - 12 5/8"
M2	± S + 2 7/8"	± TB - 15 1/8"

DE Hawa Folding Concepta III Push links, Hawa Concepta III Push rechts
FR Hawa Folding Concepta III Push, à gauche, Hawa Concepta III Push, à droite
EN Hawa Folding Concepta III Push, left, Hawa Concepta III Push, right
IT Hawa Folding Concepta III Push, a sinistra, Hawa Concepta III Push, a destra
ES Hawa Folding Concepta III Push izquierda, Hawa Concepta III Push derecha

DE Abkürzungen / FR Abréviations / EN Abbreviations / IT Abbreviazioni / ES Abreviaturas

DE	FR	EN	IT	ES
BS Beschlagselende	Epaisseur du côté extérieur	Fitting side thickness	Spessore lato ferramenta	Grosor del lado del herraje
E Einschubtiefe	Profondeur d'encastrement	Slide-in depth	Profondità di inserimento	Profundidad de introducción
EH Einbauhöhe	Hauteur d'encastrement	Installation height	Altezza d'incasso	Altura de montaje
KT Korpusiefe	Profondeur de corps	Cabinet depth	Profondità mobile	Profundidad del mueble
LMB Lichteinbaubreite	Largeur intérieure	Inside clearance	Larghezza luce	Ancho interior
M Türüberstand über Korpus	Saillie de la porte par rapport au corps	Door projection over cabinet	Sporgenza anta sopra il mobile	Solape de la puerta sobre el cuerpo
S Türdicke	Épaisseur de porte	Door thickness	Spessore anta	Grosor de la puerta
T Beschlagtiefe	Profondeur de ferrure	Hardware depth	Altezza di montaggio	Profundidad del herraje
TA Türschwelle	Ecartement d'axe de la charnière invisible	Hardware depth of concealed hinge	Distanza scalcina asse	Distancia de la cazoleta
TB Türbreite	Largeur de porte	Door width	Larghezza anta	Ancho de puerta
TH Türhöhe	Hauteur de porte	Door height	Altezza anta	Altura de puerta
Z Lutzzwischenraum	Jeu dans l'espacement	Air gap	Tralero d'aria	Espacio libre

DE Aussenseite A
FR Face extérieure A
EN Outer face A
IT Lato esterno A
ES Lateral exterior A

DE Beschlagsseite B
FR Côte de la ferrure B
EN Fitting side B
IT Lato ferramenta B
ES Lado del herraje B

DE Falttüre Folding Concepta III 25 Push
FR Porte pliante Folding Concepta III 25 Push
EN Folding Concepta III 25 Push folding door
IT Porta a libro Folding Concepta III 25 Push
ES Puerta plegable Folding Concepta III 25 Push

DE Falttüre Folding Concepta III 20 Push
FR Porte pliante Folding Concepta III 20 Push
EN Folding Concepta III 20 Push folding door
IT Porta a libro Folding Concepta III 20 Push
ES Puerta plegable Folding Concepta III 20 Push

DE Drehtüre Folding Concepta III 25 Push
FR Porte tournante Folding Concepta III 25 Push
EN Folding Concepta III 25 Push pivot door
IT Porta girevole Folding Concepta III 25 Push
ES Puerta giratoria Folding Concepta III 25 Push

DE Drehtüre Folding Concepta III 20 Push
FR Porte tournante Folding Concepta III 20 Push
EN Folding Concepta III 20 Push pivot door
IT Porta girevole Folding Concepta III 20 Push
ES Puerta giratoria Folding Concepta III 20 Push

DETAIL H 2:1

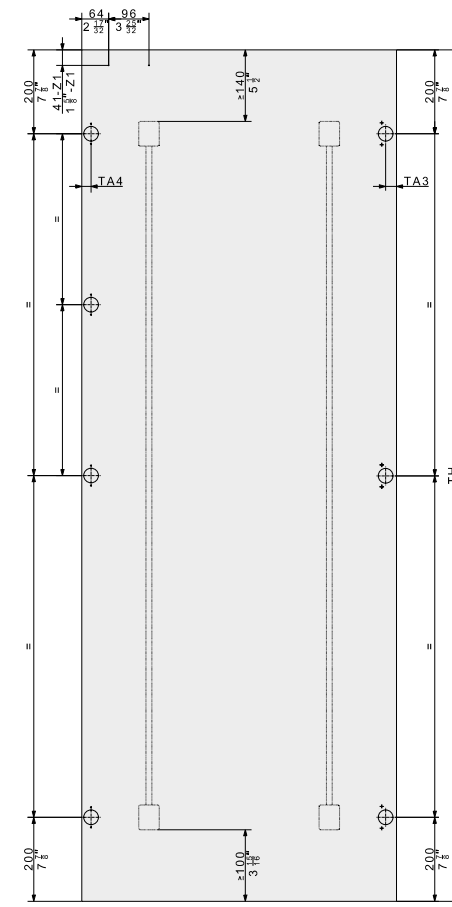
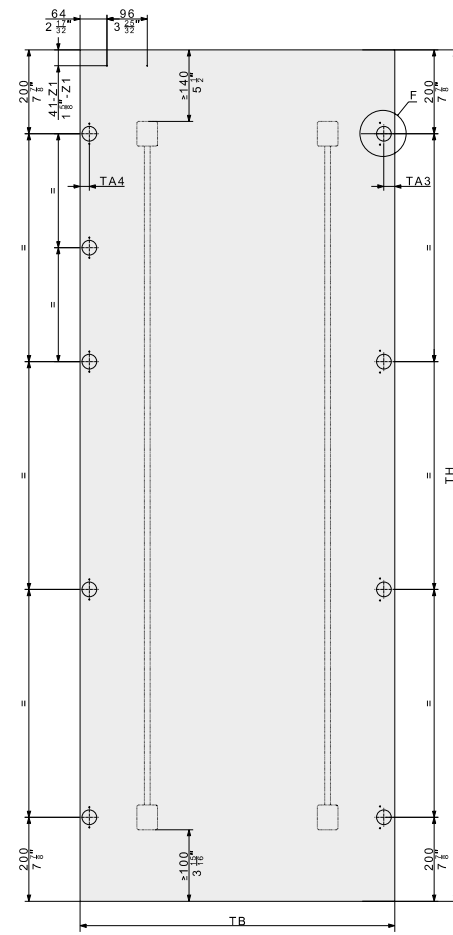
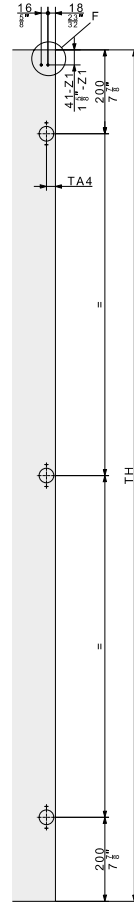
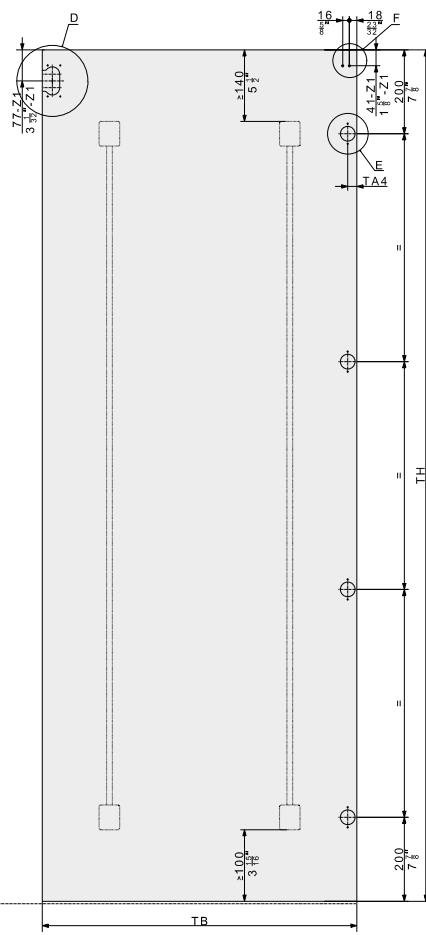
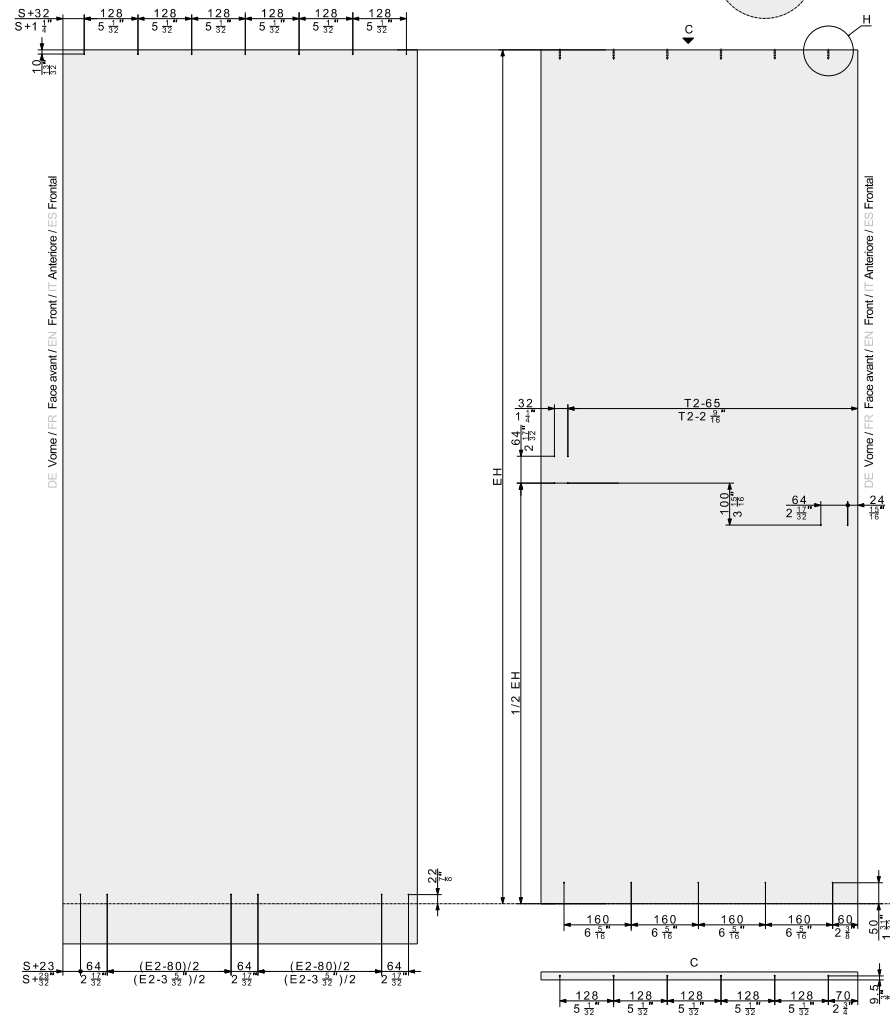
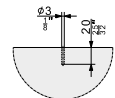

DETAIL D 2:1

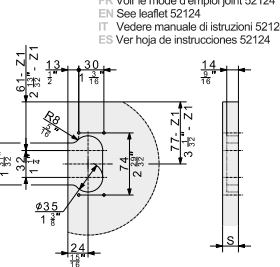

DETAIL E 2:1

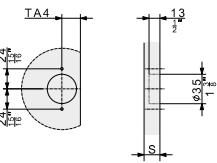

Z5	TA4
2 mm (1/16")	22.5 mm (7/8")
3 mm (1/8")	22 mm (7/8")
4 mm (1/4")	21.5 mm (7/8")
5 mm (3/16")	21 mm (7/8")

DETAIL F 2:1

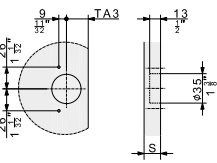

Z3	TA3
2 mm (1/16")	29 mm (1 1/8")
3 mm (1/8")	28 mm (1 1/8")
4 mm (1/4")	27 mm (1 1/8")
5 mm (3/16")	26 mm (1 1/8")

Detail G 2:1

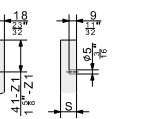

DE Schrankdeckel
FR Couvercle d'armoire
EN Cabinet lid
IT Coperchio del mobile
ES Tapa del armario

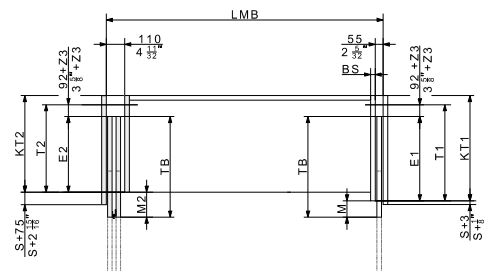
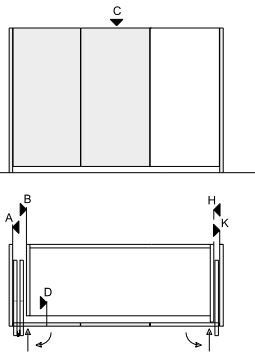
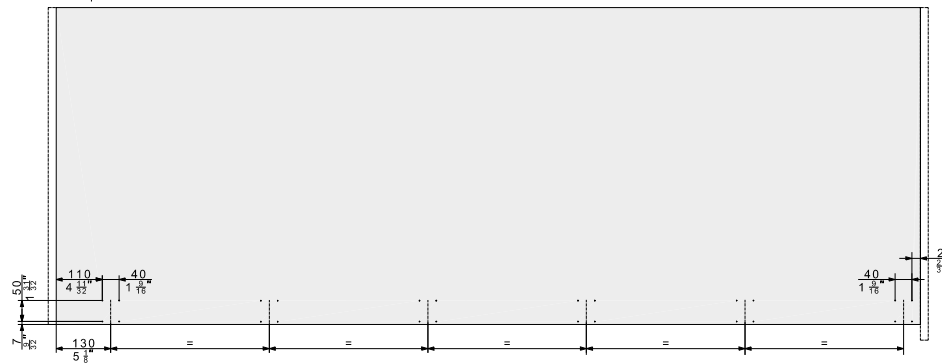

mm	Inch
T2	TB + 92 + Z3 - M2
E2	TB - M2
KT2	± T2
M2	± S + 75 ± TB - 390

mm	Inch
BS	± 19 ± 3/4"
S	18 - 26 23/32" - 1 1/8"
T2	± 344 ± 1 1/16"
TB	440 - 750 1' 5 3/8" - 2' 5 3/8"
TH (III 20)	1200 - 2200 3' 11 1/4" - 7' 2 3/8"
TH (III 25)	1900 - 2700 6' 2 1/8" - 8' 10 3/8"
Z1	0 - 6 0 - 1/4"
Z2	0 - 6 0 - 1/4"
Z3	2 - 5 3/8" - 3/8"
Z5	2 - 5 3/8" - 3/8"

DE Abkürzungen / FR Abréviations / EN Abbreviations / IT Abbreviazioni / ES Abreviaturas

DE	FR	EN	IT	ES
BS Beschlagsleiste	Epaisseur du côté extérieur	Fitting side thickness	Spessore lato ferramenta	Grosor del lado del herraje
E Einschubtiefe	Profondeur d'escamotage	Slide-in depth	Profondità di inserimento	Profundidad de introducción
EH Einbauhöhe	Hauteur d'encastrement	Installation height	Altezza d'incasso	Altura de montaje
KT Korpusiefe	Profondeur de corps	Cabinet depth	Profondità mobile	Profundidad del mueble
LMB Lichtmassbreite	Largeur intérieure	Inside clearance	Larghezza luce	Ancho interior
M Türüberstand über Korpus	Saillie de la porte par rapport au corps	Door projection over cabinet	Sporgenza anta sopra il mobile	Solape de la puerta sobre el cuerpo
S Türdicke	Epaisseur de porte	Door thickness	Spessore anta	Grosor de la puerta
T Beschlagsiefe	Profondeur de ferrure	Hardware depth	Profondità ferramenta	Profundidad del herraje
TA Türschwelle	Ecartement d'axe de la charnière invisible	Axis-centre distance of concealed hinge	Distanza scalcina asse	Distancia de la cazuela
TB Türbreite	Largeur de porte	Door width	Larghezza anta	Ancho de puerta
TH Türhöhe	Hauteur de porte	Door height	Altezza anta	Altura de puerta
Z Zwischenraum	Jeu dans l'espacement	Air gap	Tralero d'aria	Espacio libre

DE Hawa Folding Concepta III Push links, Hawa Concepta III Push rechts
FR Hawa Folding Concepta III Push, à gauche, Hawa Concepta III Push, à droite
EN Hawa Folding Concepta III Push, left, Hawa Concepta III Push, right
IT Hawa Folding Concepta III Push, a sinistra, Hawa Concepta III Push, a destra
ES Hawa Folding Concepta III Push izquierda, Hawa Concepta III Push derecha

Hawa Folding Concepta III Push links, Hawa Concepta III Push rechts
161986 V03 2/3

Rev. Ver.: 21.12.2023 BBU
Rev. Ver.: 30.05.2024 SSI

DE Aussenseite K
FR Face extérieure K
EN Outer face K
IT Lato esterno K
ES Lateral exterior K

DE Beschlagselle H
FR Côte de la ferrure H
EN Fitting side H
IT Lato ferramenta H
ES Lado del herraje H

DE Türe Concepta III 25 Pull
FR Porte Concepta III 25 Pull
EN Door Concepta III 25 Pull
IT Anta Concepta III 25 Pull
ES Puerta Concepta III 25 Pull

DE Türe Concepta III 35 Push
FR Porte Concepta III 35 Push
EN Door Concepta III 35 Push
IT Anta Concepta III 35 Push
ES Puerta Concepta III 35 Push

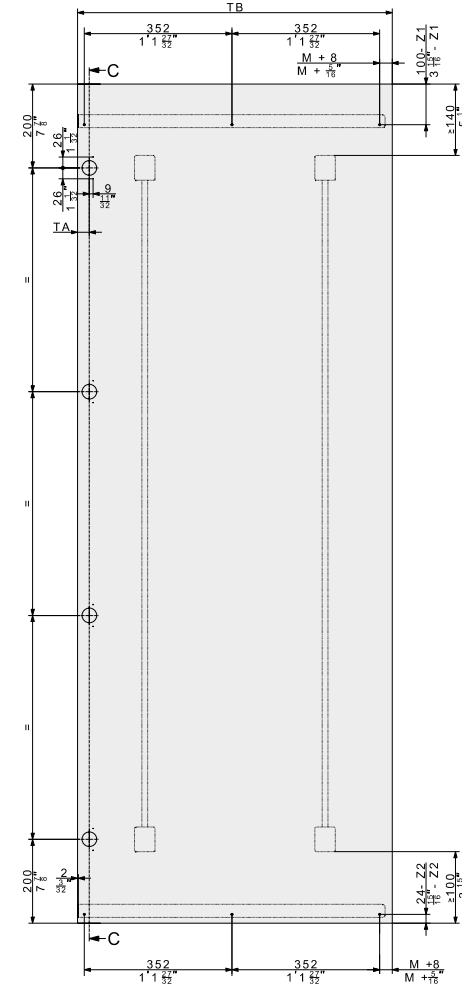
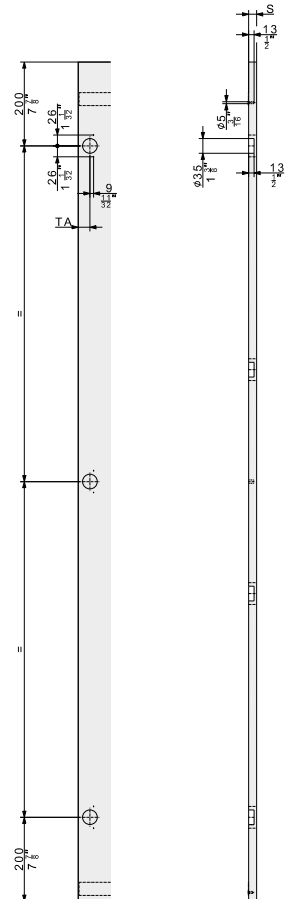
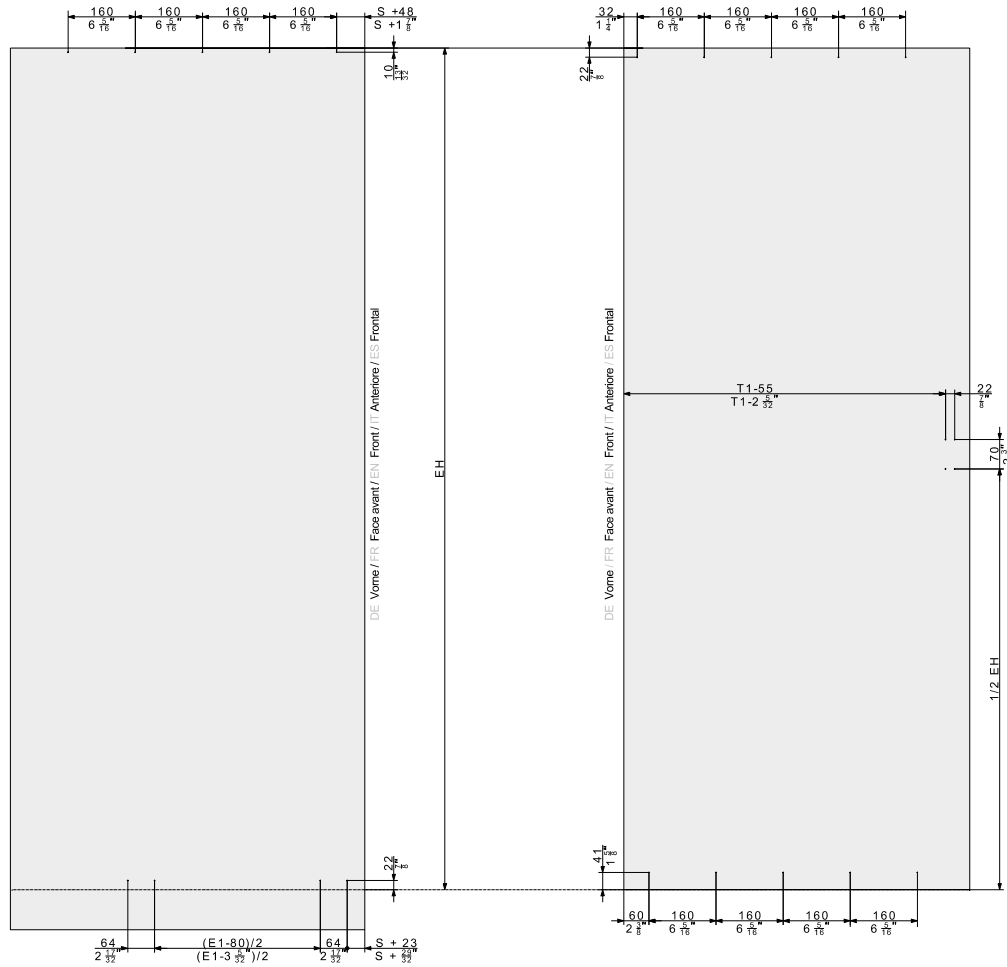

DE Stahlprofil, rechts.
FR Profil en acier, à droite.
EN Steel profile, right.
IT Profilo in acciaio, a destra.
ES Perfil de acero, derecha.

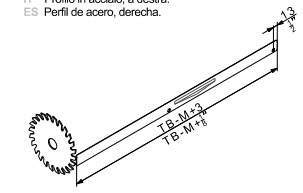

Hawa Concepta III 25 Push

DE Maximale Gewichte in kg / FR Poids maximale en kg /
EN Maximum weights in kg / IT Pesi massimi in kg /
ES Pesos máximos en kg

DE Türbreite / FR Largeur de porte / EN Door width /
IT Larghezza anta / ES Ancho de puerta

	440	500	550	600	650	700	750
2200	25	25	25	25	25	25	24
2150	25	25	25	25	25	25	23
2100	25	25	25	25	25	24	23
2050	25	25	25	25	25	24	22
2000	25	25	25	25	25	23	21
1950	25	25	25	25	24	22	21
1900	25	25	25	25	23	21	20
1850	25	25	25	24	22	21	19
1800	25	25	25	23	21	20	19
1750	25	25	25	22	21	19	18
1700	25	25	24	22	20	19	17
1650	25	25	23	21	19	18	17
1600	25	24	22	20	18	17	16
1550	25	23	21	19	18	16	15
1500	24	22	20	18	17	16	15
1450	23	21	19	17	16	15	14
1400	22	20	18	17	15	14	13
1350	21	19	17	16	15	14	13
1300	20	18	16	15	14	13	12
1250	19	17	15	14	13	12	11
1200	18	16	15	13	12	11	11

DE Türhöhe / FR Hauteur de porte / EN Door height /
IT Altezza anta / ES Altura de puerta

DE Türgewicht in kg / FR Poids de porte en kg /
EN Door weight in kg / IT Peso anta in kg /
ES Peso de puerta en kg

Hawa Concepta III 35 Push

DE Maximale Gewichte in kg / FR Poids maximale en kg /
EN Maximum weights in kg / IT Pesi massimi in kg /
ES Pesos máximos en kg

DE Türbreite / FR Largeur de porte / EN Door width /
IT Larghezza anta / ES Ancho de puerta

	440	500	550	600	650	700	750
2700	35	35	35	35	35	35	35
2650	35	35	35	35	35	35	35
2600	35	35	35	35	35	35	35
2550	35	35	35	35	35	35	35
2500	35	35	35	35	35	35	35
2450	35	35	35	35	35	35	34
2400	35	35	35	35	35	35	33
2350	35	35	35	35	35	34	32
2300	35	35	35	35	35	34	31
2250	35	35	35	35	35	33	31
2200	35	35	35	35	34	32	30
2150	35	35	35	35	33	31	29
2100	35	35	35	35	32	30	28
2050	35	35	35	34	31	29	27
2000	35	35	35	33	30	28	26
1950	35	35	35	32	29	27	26
1900	35	35	34	31	29	27	25

DE Türhöhe / FR Hauteur de porte / EN Door height /
IT Altezza anta / ES Altura de puerta

DE Türgewicht in kg / FR Poids de porte en kg /
EN Door weight in kg / IT Peso anta in kg /
ES Peso de puerta en kg

Hawa Concepta III 25 Push

DE Maximale Gewichte in lbs. / FR Poids maximale en lbs. /
EN Maximum weights in lbs. / IT Pesi massimi in lbs. /
ES Pesos máximos en lbs.

DE Türbreite / FR Largeur de porte / EN Door width /
IT Larghezza anta / ES Ancho de puerta

	1' 5 3/8"	1' 7 11/16"	1' 9 23/32"	1' 11 5/8"	2' 1 19/32"	2' 3 9/16"	2' 5 17/32"
7' 2 3/8"	55	55	55	55	55	55	53
7' 0 3/4"	55	55	55	55	55	55	51
6' 10 1/8"	55	55	55	55	55	53	51
6' 8 3/8"	55	55	55	55	55	53	49
6' 6 1/4"	55	55	55	55	55	51	46
6' 4 3/8"	55	55	55	55	53	49	46
6' 2 3/8"	55	55	55	55	51	46	44
6' 0 3/4"	55	55	55	53	49	46	42
5' 10 1/4"	55	55	55	51	46	44	42
5' 8 3/8"	55	55	55	49	46	42	40
5' 6 3/8"	55	55	53	49	44	42	37
5' 4 3/8"	55	55	51	46	42	40	37
5' 3"	55	53	49	44	40	37	35
5' 1 3/8"	55	51	46	42	40	35	33
4' 11 1/4"	53	49	44	40	37	35	33
4' 9 3/8"	51	46	42	37	35	33	31
4' 7 3/8"	49	44	40	37	33	31	29
4' 5 3/8"	46	42	37	35	33	31	29
4' 3 3/8"	44	40	35	33	31	29	26
4' 1 3/8"	42	37	33	31	29	26	24
3' 11 1/4"	40	35	33	29	26	24	24

DE Türhöhe / FR Hauteur de porte / EN Door height /
IT Altezza anta / ES Altura de puerta

DE Türgewicht in lbs. / FR Poids de porte en lbs. /
EN Door weight in lbs. / IT Peso anta in lbs. /
ES Peso de puerta en lbs.

Hawa Concepta III 35 Push

DE Maximale Gewichte in lbs. / FR Poids maximale en lbs. /
EN Maximum weights in lbs. / IT Pesi massimi in lbs. /
ES Pesos máximos en lbs.

DE Türbreite / FR Largeur de porte / EN Door width /
IT Larghezza anta / ES Ancho de puerta

	1' 5 3/8"	1' 7 11/16"	1' 9 23/32"	1' 11 5/8"	2' 1 19/32"	2' 3 9/16"	2' 5 17/32"
8' 10 1/8"	77	77	77	77	77	77	77
8' 8 3/8"	77	77	77	77	77	77	77
8' 6 1/4"	77	77	77	77	77	77	77
8' 4 3/8"	77	77	77	77	77	77	77
8' 2 3/8"	77	77	77	77	77	77	77
8' 0 3/4"	77	77	77	77	77	77	75
7' 10 3/8"	77	77	77	77	77	77	73
7' 8 3/8"	77	77	77	77	77	75	71
7' 6 3/8"	77	77	77	77	77	75	68
7' 4 3/8"	77	77	77	77	77	73	68
7' 2 3/8"	77	77	77	77	75	71	66
7' 0 3/4"	77	77	77	77	73	68	64
6' 10 1/8"	77	77	77	77	71	66	62
6' 8 3/8"	77	77	77	75	68	64	60
6' 6 1/4"	77	77	77	73	66	62	57
6' 4 3/8"	77	77	77	71	64	60	57
6' 2 3/8"	77	77	75	68	64	60	55

DE Türhöhe / FR Hauteur de porte / EN Door height /
IT Altezza anta / ES Altura de puerta

DE Türgewicht in lbs. / FR Poids de porte en lbs. /
EN Door weight in lbs. / IT Peso anta in lbs. /
ES Peso de puerta en lbs.

DE Hawa Folding Concepta III Push links, Hawa Concepta III Push rechts
FR Hawa Folding Concepta III Push, à gauche, Hawa Concepta III Push, à droite
EN Hawa Folding Concepta III Push, left, Hawa Concepta III Push, right
IT Hawa Folding Concepta III Push, a sinistra, Hawa Concepta III Push, a destra
ES Hawa Folding Concepta III Push izquierda, Hawa Concepta III Push derecha

Hawa Folding Concepta III Push links, Hawa Concepta III Push rechts
161996 V03 3/3

Gen.Verf.: 21.12.2023/BBU
Rev.Verf.: 30.05.2024/SJS

DE	FR	EN	IT	ES
BS Beschlagselentiecke	Epaisseur du côté extérieur	Fitting side thickness	Spessore lato ferramenta	Grosor del lado del herraje
E Einschubtiefe	Profondeur d'encastrement	Slide-in depth	Profondità di inserimento	Profundidad de introducción
EH Einbauhöhe	Hauteur d'encastrement	Installation height	Altezza d'incasso	Altura de montaje
KT Korpusiefe	Profondeur de corps	Cabinet depth	Profondità mobile	Profundidad del mueble
LMB Lichtmassbreite	Largeur intérieure	Inside clearance	Larghezza luce	Ancho interior
M Türüberstand über Korpus	Saillie de la porte par rapport au corps	Door projection over cabinet	Sporgenza anta sopra il mobile	Solape de la puerta sobre el cuerpo
S Türdicke	Epaisseur de porte	Door thickness	Spessore anta	Grosor de la puerta
T Türschliefentiefe	Profondeur de ferrure	Hardware depth	Profondità ferramenta	Profundidad del herraje
TA Trofischabstand	Ecartement d'axe de la charnière invisible	Axis-centre distance of concealed hinge	Distanza scalcina asse	Distancia de la carzola
TB Türbreite	Largeur de porte	Door width	Larghezza anta	Ancho de puerta
TH Türhöhe	Hauteur de porte	Door height	Altezza anta	Altura de puerta
Z Lutzzwischenraum	Jeu dans l'espacement	Air gap	Trafiero d'anta	Espacio libre