







**Fitting for 2-3 top-running wooden doors up to 36 kg (79 lbs.), with groove mounted running track. With soft and self closing mechanism. Design Inside.**

**Product highlights**

-  **Flexibility** Wide range of applications for sliding door cabinets in any dimension
-  **Productivity** Easy installation with tool-less clip-on system and convenient height adjustment

**Technical specifications**

-  Max. 36 kg (79 lbs.)
-  Max. 2200 mm (7'2 5/8")
-  Max. 1000 mm (3'3 3/8")
-  19-25 mm (3/4" to 31/32")

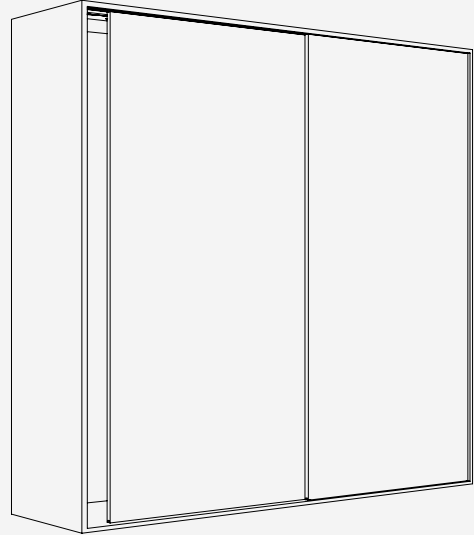

**Installation examples**

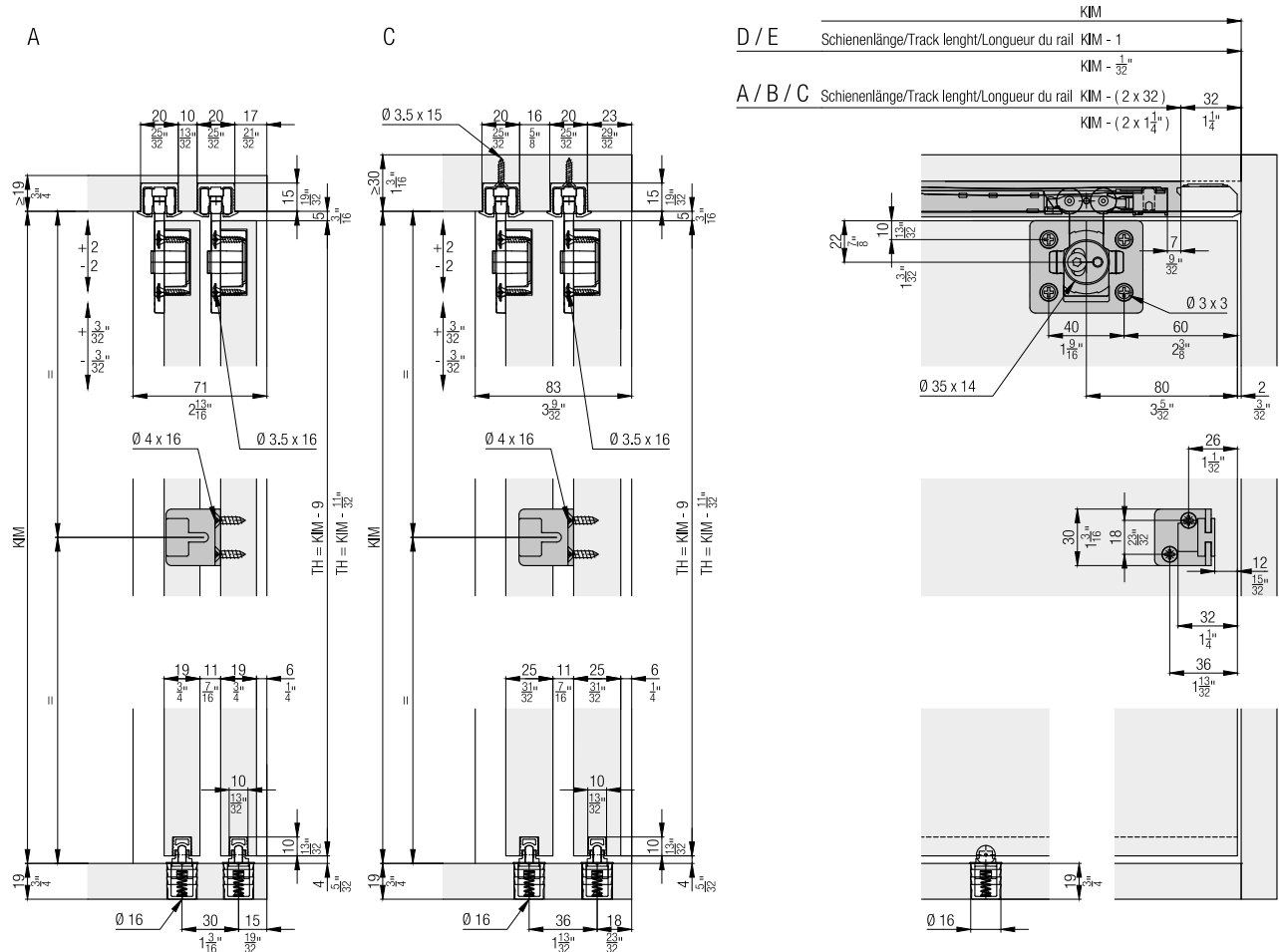







**Set for 2 wooden doors up to 36 kg (79 lbs.),  
with height adjustment**

	No.
Hawa Clipo 36 H IS, for 2 doors	053.3353.072



Set consisting of:		053.3353.072	No.
	Running gear double, left	2	053.3346.071
	Running gear double, right	2	053.3347.071
	Stopper, plastic, gray	4	057.3148.071
	Housing, plastic	4	053.0332.001
	Fillister head screw, 3.5x16 mm (5/32"x5/8"), steel, zinc-plated	16	766.6052.100
	Follower Hawa Combino/ Hawa Clipo, plastic	1	055.3123.071
	Adapter to follower steel, zinc-plated	1	055.0213.101
	Flat countersunk head chipboard screw 4x16 mm (5/32"x5/8"), steel, zinc-plated	2	600.0000.253
	Bottom guide, plastic, gray	2	055.3081.071

**Set for 3 wooden doors up to 36 kg (79 lbs.),  
with height adjustment**

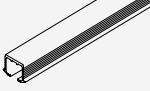
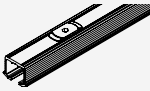
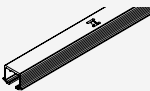
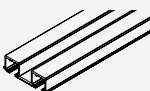

	No.
Hawa Clipo 36 H IS, for 3 doors	053.3353.073

Set consisting of:		053.3353.073	No.
	Running gear double, left	3	053.3346.071
	Running gear double, right	3	053.3347.071
	Stopper, plastic, gray	4	057.3148.071
	Housing, plastic	6	053.0332.001
	Fillister head screw, 3.5x16 mm (5/32"x5/8"), steel, zinc-plated	24	766.6052.100
	Buffer, with adhesive	2	061.3083.001
	Bottom guide, plastic, gray	3	055.3081.071

**Running tracks**

		mm (inch)	No.
	A: Single running track, for glue fixing, aluminum, anodized	2,500 (8' 2 7/16")	053.3324.250
		3,500 (11' 5 25/32")	053.3324.350
		6,000 (19' 8 7/32")	053.3324.600
	B: Single running track, swivel lug, aluminum, anodized (not for hard wood/ MDF)	2,500 (8' 2 7/16")	053.3327.250
		3,500 (11' 5 25/32")	053.3327.350
		6,000 (19' 8 7/32")	053.3327.600
	C: Single running track, for screw fixing, aluminum, anodized	2,500 (8' 2 7/16")	053.3325.250
		3,500 (11' 5 25/32")	053.3325.350
		6,000 (19' 8 7/32")	053.3325.600
	D: Double running track, for screw fixing, aluminum, anodized, for door thickness of 25 mm (31/32")	2,500 (8' 2 7/16")	053.3328.250
		3,500 (11' 5 25/32")	053.3328.350
		6,000 (19' 8 7/32")	053.3328.600
	E: Double running track, for screw fixing, aluminum, anodized, for door thickness of 19 mm (3/4")	2,500 (8' 2 7/16")	053.3339.250
		3,500 (11' 5 25/32")	053.3339.350
		E: Double running track, for screw fixing, aluminum, anodized, for door thickness of 19 mm (3/4")	6,000 (19' 8 7/32")

**Track end piece set for single running tracks**

		No.	
Track-end section, for screw fixing, plastic, gray, 2-piece set		053.3354.071	
Track-end section, swivel lug, plastic, gray, 2-piece set		053.3355.051	
		053.3354.071	053.3355.051
		No.	
<b>Set consisting of:</b>			
	Track-end piece, for screw fixing, plastic	2	053.0334.001
	Chipboard screw, 4x12 mm (5/32"x15/32"), steel, zinc-plated	2	600.0000.704
	Track-end piece, with swivel lug, plastic	2	053.3351.071

**Guide tracks**

		mm (inch)	No.
	Guide track, for glue fixing, plastic, gray	2,500 (8' 2 7/16")	055.3171.250
		3,500 (11' 5 25/32")	055.3171.350
		6,000 (19' 8 7/32")	055.3171.600

**Panels**

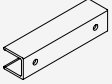

		mm (inch)	No.
	Panel for 053.3339., aluminum, anodized	2,500 (8' 2 7/16")	053.5050.250
		3,500 (11' 5 25/32")	053.5050.350
		6,000 (19' 8 7/32")	053.5050.600

**Clip-on components**

		No.
	Clip component for wooden panel, for 053.3339, every 700-800 mm (2' 3 9/16" to 2' 7 15/32"), aluminum, pre-drilled	053.5051.001

**Soft close up to 15/26/36 kg (33/57/79 lbs.)**

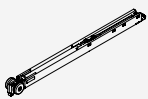

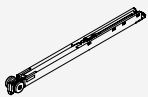
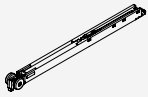
	No.
Soft close, up to 15 kg (33 lbs.)	057.3159.071
Soft close, up to 26 kg (57 lbs.)	057.3159.072
Soft close, up to 40 kg (88 lbs.)	057.3159.073

Set consisting of:				No.
	057.3159.071	057.3159.072	057.3159.073	
 Soft close, up to 15 kg (33 lbs.)	2			057.3156.071
 Release piece soft close	2	2	2	057.0182.101
 Thread rolling rounded head screw, M2.5x5 mm (3/32"x3/16"), steel, zinc-plated	2	2	2	600.0000.764
 Soft close, up to 26 kg (57 lbs.)		2		057.3156.072
 Soft close, up to 40 kg (88 lbs.)			2	057.3156.073

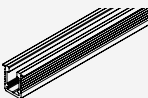
**Guide tracks 4-point guidance**



	mm (inch)	No.
 Single guide track, for glue fixing, aluminum, anodized	6,000 (19' 8 7/32")	053.3296.600

**Components 4-point guidance**

	No.
 Bottom guide Hawa Clipo IS/Hawa Regal C 16, plastic, anthracite	040.3124.071
 Stopper guide track, plastic, grey	053.5094.071

**Door centering**

	No.
Door centering, plastic, anthracite, for 2 doors	053.3207.071

Set consisting of:			No.
	053.3207.071		
 Housing door centering, plastic, anthracite	2		053.5014.001
 Pin door centering, plastic, anthracite	2		053.0171.001
 Rubber buffer, plastic, grey	1		025.0107.001

**Accessories**

	No.
 Track cleaner, plastic, red	040.3142.071

Further installation examples

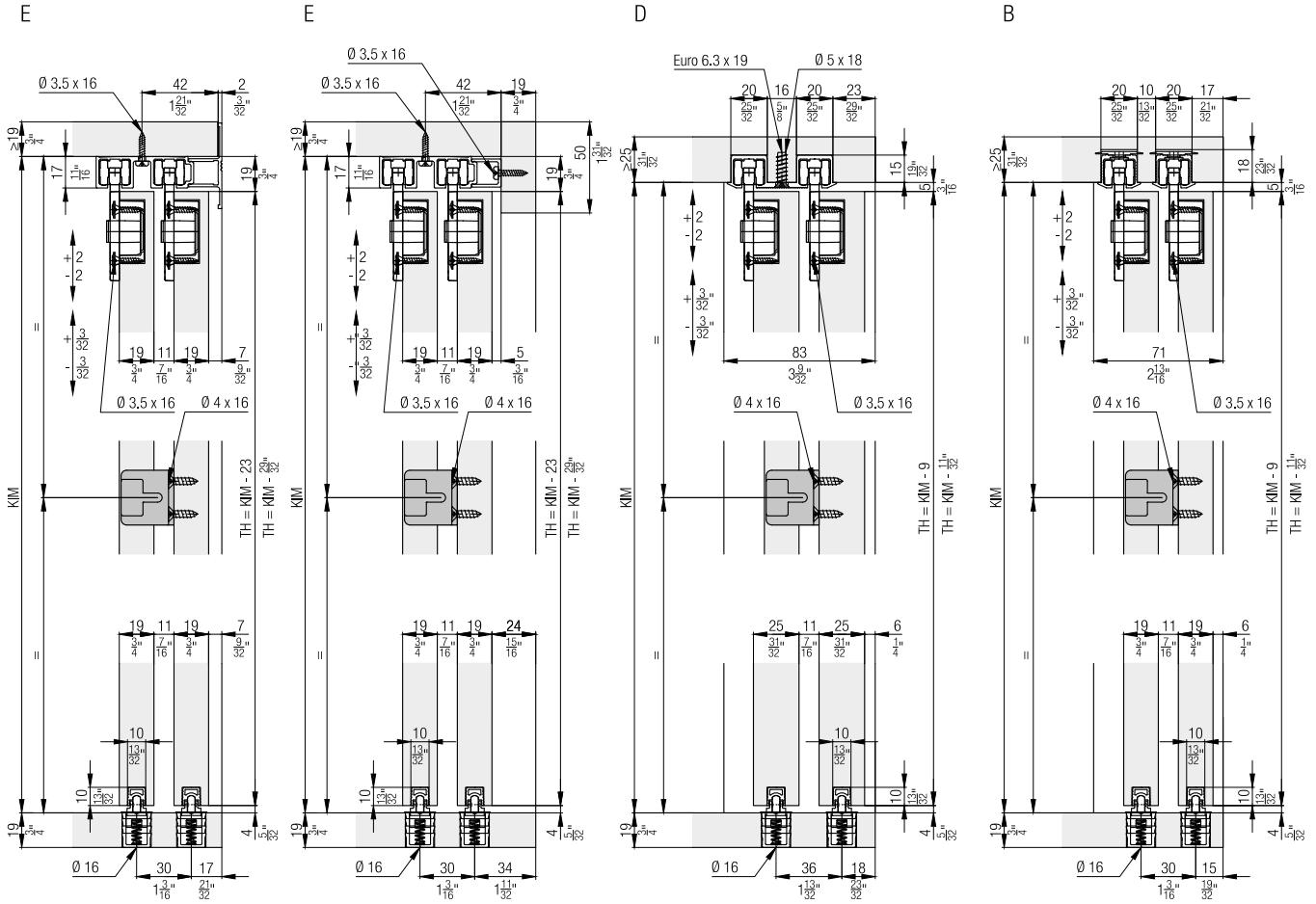

Calculations

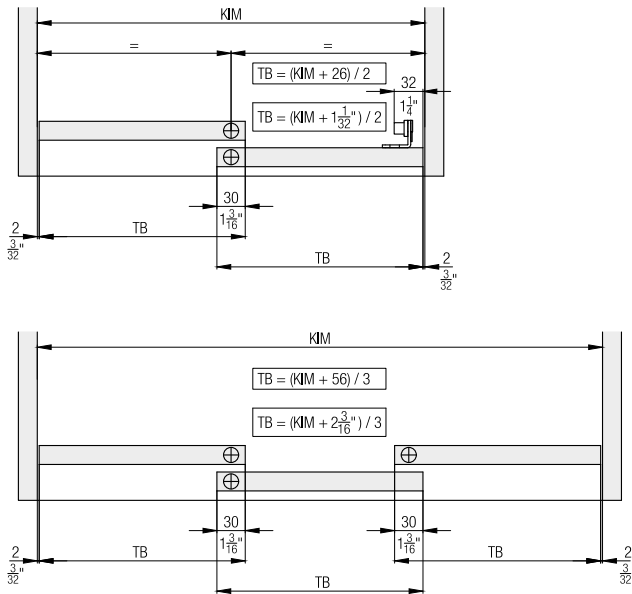

4 point guidance

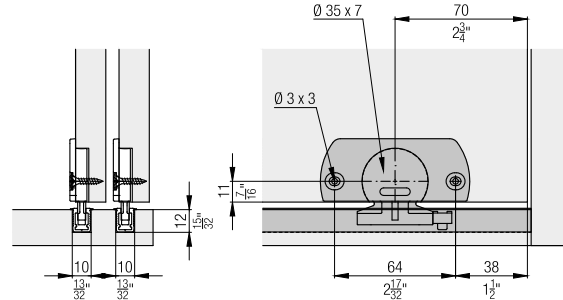

Door centering

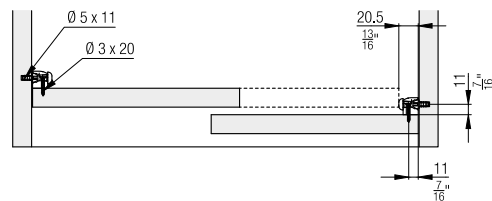

Soft close

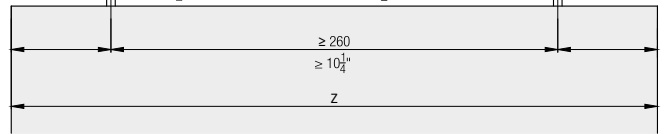

	Z ≥	
	1	2
Hawa Porta 40 H	1' 4 <sup>17</sup> / <sub>32</sub> "	2' 0 <sup>13</sup> / <sub>32</sub> "
Hawa Porta 40 GE	1' 2 <sup>13</sup> / <sub>16</sub> "	1' 10 <sup>11</sup> / <sub>16</sub> "
Hawa Clipo 26 H IS	1' 4 <sup>17</sup> / <sub>32</sub> "	2' 0 <sup>13</sup> / <sub>32</sub> "
Hawa Clipo 26 H MS	1' 6 <sup>1</sup> / <sub>32</sub> "	2' 1 <sup>29</sup> / <sub>32</sub> "
Hawa Clipo 36 H IS	1' 4 <sup>17</sup> / <sub>32</sub> "	2' 0 <sup>13</sup> / <sub>32</sub> "
Hawa Clipo 36 H MS	1' 6 <sup>1</sup> / <sub>32</sub> "	2' 1 <sup>29</sup> / <sub>32</sub> "
Hawa Clipo 36 HM IS	1' 4 <sup>17</sup> / <sub>32</sub> "	2' 0 <sup>13</sup> / <sub>32</sub> "
Hawa Clipo 26 GR IS	1' 4 <sup>17</sup> / <sub>32</sub> "	2' 0 <sup>13</sup> / <sub>32</sub> "
Hawa Clipo 36 G IS	1' 4 <sup>17</sup> / <sub>32</sub> "	2' 0 <sup>13</sup> / <sub>32</sub> "
Hawa Clipo 36 GPK IS	1' 4 <sup>17</sup> / <sub>32</sub> "	2' 0 <sup>13</sup> / <sub>32</sub> "
Hawa Clipo 36 GPPK IS	1' 4 <sup>17</sup> / <sub>32</sub> "	2' 0 <sup>13</sup> / <sub>32</sub> "
Hawa Regal C 26 HM IS	1' 4 <sup>17</sup> / <sub>32</sub> "	2' 0 <sup>13</sup> / <sub>32</sub> "
Hawa Regal C 26 GR IS	1' 3 <sup>3</sup> / <sub>4</sub> "	1' 11 <sup>5</sup> / <sub>8</sub> "

	Z ≥	
	1	2
Hawa Porta 40 H	420	620
Hawa Porta 40 GE	376	576
Hawa Clipo 26 H IS	420	620
Hawa Clipo 26 H MS	458	658
Hawa Clipo 36 H IS	420	620
Hawa Clipo 36 H MS	458	658
Hawa Clipo 36 HM IS	420	620
Hawa Clipo 26 GR IS	420	620
Hawa Clipo 36 G IS	420	620
Hawa Clipo 36 GPK IS	420	620
Hawa Clipo 36 GPPK IS	420	620
Hawa Regal C 26 HM IS	420	620
Hawa Regal C 26 GR IS	400	600

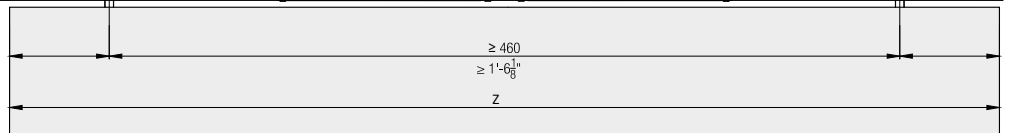

Accessories

– Straightening fitting from page 236

Planning/execution

Further information about the product can be found on [www.hawa.com](http://www.hawa.com).