







**Fitting for top-running wooden doors up to 100 kg (220 lbs.), with surface mounted running track or running track flush with the ceiling. Optionally with soft and self closing mechanism. Wall or ceiling mounting.**

**Product highlights**

-  **Comfort** Accessible opening and soft and self closing at both sides from door widths of 800 mm (2' 7 1/2")
-  **Flexibility** Running tracks for wall and ceiling mounting with integrated clip-on system
-  **Security** Performance guarantee: 15 years for private use and 7 years for commercial use on incomparably low opening forces of max. 22 N

**Technical specifications**

-  Max. 100 kg (220 lbs.)
-  Max. 4000 mm (13' 1 15/32")
-  Max. 3000 mm (9' 10 1/8")
-  35–80 mm (1 3/8" to 3 5/32")

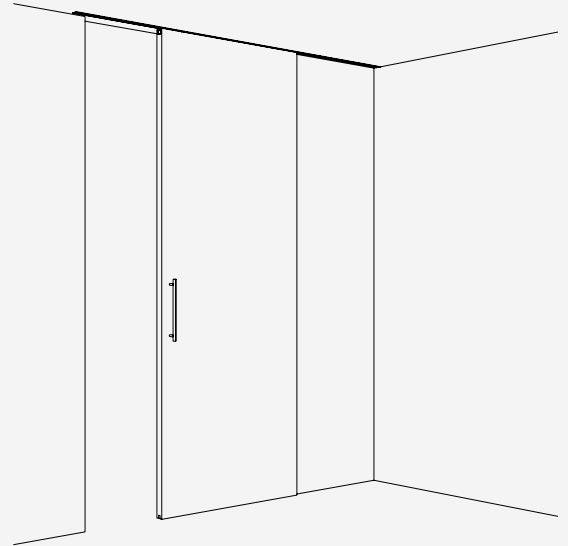

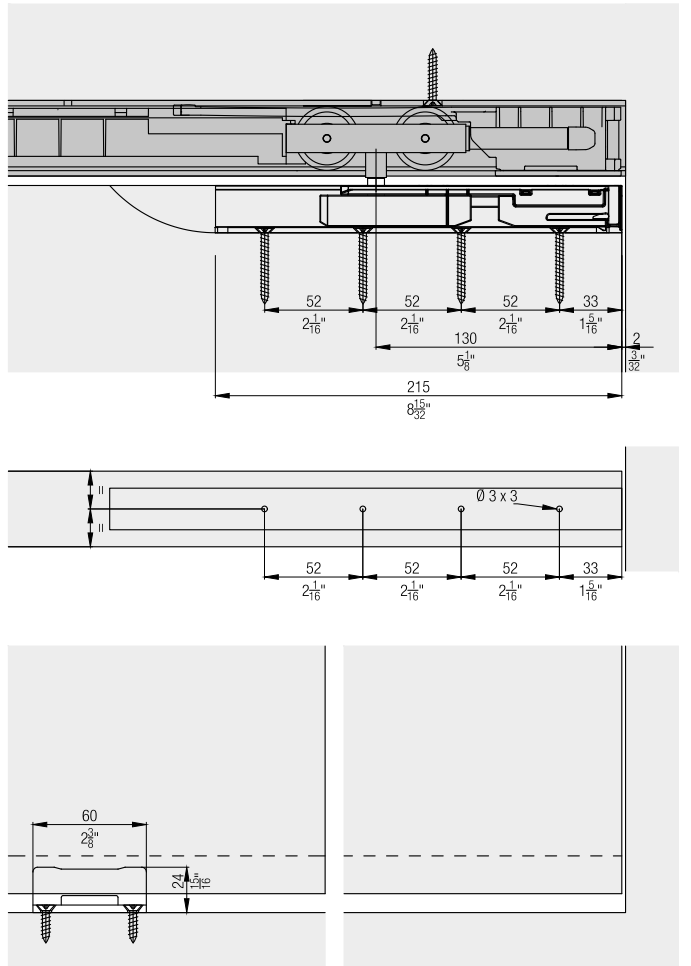
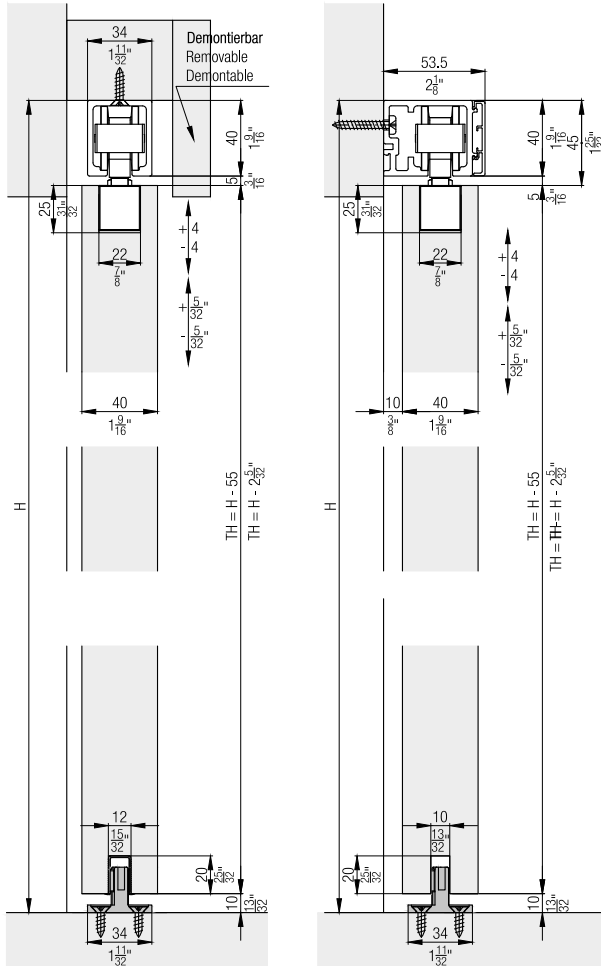

**Installation examples**



**Set for 1 wooden door up to 100 kg (220 lbs.)**

	No.
Hawa Junior 100 B, for 1 door	30152
Hawa Junior 100 B, with 20 mm (25/32") longer suspension bolt, for 1 door	30153

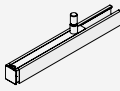

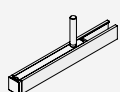
**Set consisting of:**

		30152	30153	No.
	Suspension profile, plate with screw M10	2		24246
	Bottom guide, zero tolerance, groove width 10 mm (13/32"), plastic, black	1	1	14427
	Screw-on rubber door stop	1	1	10629
	Suspension profile, plate, with 20 mm (25/32") longer screw M10, ceiling integration		2	24846

**Set for 1 wooden door, with running gears and magnetic soft closing mechanism**

	No.
Hawa Junior 100, 2 running gears, for 1 door	30064
Hawa Junior 100, 1 running gear, 1 SoftMove 100 with running gear and stopper, for 1 door	30149
Hawa Junior 100, 2 SoftMove 100 with running gear and stopper, for 1 door	30150

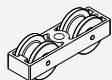
**Set consisting of:**

		30064	30149	30150	No.
	Running gear, 2-wheeled, M10, ball bearing	2	1		30137
	Soft close SoftMove 100, with running gear, stopper and cover, premounted		1	2	30509

**Accessories for set**

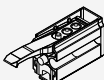
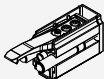
	No.	
	Stopper Hawa Junior 80/100, with adjustable retention spring	30138
	SoftStop Hawa Junior 80/100, with adjustable retention spring	27771

**Complete set for 1 wooden door, with SoftMove and/or SoftStop**

	No.
Hawa Junior 100 B, with 2 SoftStop, for 1 door	30225
Hawa Junior 100 B, with 1 soft close SoftMove 100 and 1 SoftStop, for 1 door	30227
Hawa Junior 100 B, with 2 soft close SoftMove 100, for 1 door	30228

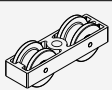
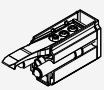
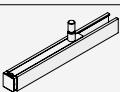

**Set consisting of:**

		30225	30227	30228	No.
	Running gear, 2-wheeled, M10, ball bearing	2	1		30137
	SoftStop Hawa Junior 80/100, with adjustable retention spring	2	1		27771
	Suspension profile, plate with screw M10	2	2	2	24246
	Bottom guide, zero tolerance, groove width 10 mm (13/32"), plastic, black	1	1	1	14427
	Soft close SoftMove 100, with running gear, stopper and cover, premounted		1	2	30509

**Complete set for 1 wooden door, with 20 mm (25/32") longer suspension bolt**

	No.
Hawa Junior 100 B, with 20 mm (25/32") longer suspension bolt, 2 SoftStop, for 1 door	30230
Hawa Junior 100 B, with 20 mm (25/32") longer suspension bolt, 1 soft close SoftMove 100 and 1 SoftStop, for 1 door	30232
Hawa Junior 100 B, with 20 mm (25/32") longer suspension bolt, 2 soft close SoftMove 100, for 1 door	30233

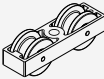
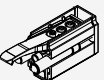
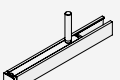
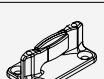
**Set consisting of:**

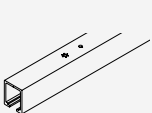

		30230	30232	30233	No.
	Running gear, 2-wheeled, M10, ball bearing	2	1		30137
	SoftStop Hawa Junior 80/100, with adjustable retention spring	2	1		27771
	Suspension profile, plate, with 20 mm longer screw M10, ceiling integration	2	2	2	24846
	Bottom guide, zero tolerance, groove width 10 mm (13/32"), plastic, black	1	1	1	14427
	Soft close SoftMove 100, with running gear, stopper and cover, premounted		1	2	30509

**Running tracks**

		mm (inch)	No.	
	Running track, aluminum, anodized, pre-drilled	1,400 (4' 7 1/8 ")	10189	
		1,600 (5' 3 ")	10190	
		1,800 (5' 10 7/8 ")	10191	
		2,000 (6' 6 3/4 ")	10192	
		2,200 (7' 2 5/8 ")	10193	
		2,500 (8' 2 7/16 ")	10194	
		3,000 (9' 10 1/8 ")	18532	
		4,000 (13' 1 15/32 ")	18533	
		6,000 (19' 8 7/32 ")	10186	
		cut to size	10188	
		Running track, aluminum, stainless steel look, brushed, pre-drilled	4,000 (13' 1 15/32 ")	20005
			6,000 (19' 8 7/32 ")	20004
			cut to size	20006

Continued table on next column

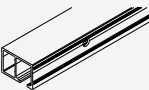
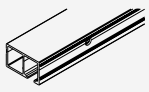
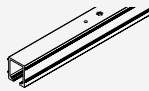
Table continued from previous column

		mm (inch)	No.
	Running track, wall mounting, aluminum, anodized, pre-drilled	2,000 (6' 6 3/4 ")	27673
		2,500 (8' 2 7/16 ")	30323
		3,000 (9' 10 1/8 ")	27672
		4,000 (13' 1 15/32 ")	30324
		6,000 (19' 8 7/32 ")	27671
		cut to size	27695
	Running track, wall mounting, extended spacing of +11 mm (7/16") between door and wall, aluminum, anodized, pre-drilled	2,500 (8' 2 7/16 ")	30613
		6,000 (19' 8 7/32 ")	30614
		cut to size	30666
	Running track, wall mounting, extended spacing of +20 mm (25/32") between door and wall, aluminum, anodized, pre-drilled	2,500 (8' 2 7/16 ")	30615
		6,000 (19' 8 7/32 ")	30616
		cut to size	30667
	Running track, ceiling mounting, aluminum, anodized, pre-drilled	2,000 (6' 6 3/4 ")	27677
		2,500 (8' 2 7/16 ")	30320
		3,000 (9' 10 1/8 ")	27676
		4,000 (13' 1 15/32 ")	30321
		6,000 (19' 8 7/32 ")	27675
		cut to size	27696
	Running track, ceiling integration, aluminum, anodized, pre-drilled	2,500 (8' 2 7/16 ")	27664
		4,000 (13' 1 15/32 ")	27663
		6,000 (19' 8 7/32 ")	30325
		cut to size	27665

**Guide tracks**

		mm (inch)	No.
	Guide track, for groove mounting, plastic, 10-piece set	1,300 (4' 3 3/16 ")	14540

**Panels**



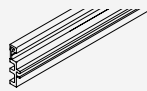

		mm (inch)	No.
	Clip-on panel to running track, aluminum, anodized	2,000 (6' 6 3/4 ")	27689
		2,500 (8' 2 7/16")	30328
		3,000 (9' 10 1/8 ")	27688
		4,000 (13' 1 15/32")	30330
		6,000 (19' 8 7/32")	27687
		cut to size	27698

**Spacer tracks**

		mm (inch)	No.
	Spacer track, for wall mounting, plastic, gray	2,000 (6'6 3/4")	057.3054.200
		cut to size	057.3054.990





**Panel end component set, 53 mm (2 3/32"), aluminum, for running track 27671, 27672, 27673, 27695, 30323, 30324**

		No.
Panel end component set, left, 53 mm (2 3/32"), anodized		30145
Panel end component set, right, 53 mm (2 3/32"), anodized		30146

		30145	30146	No.
<b>Set consisting of:</b>				
	Panel end component B, left, 53 mm (2 3/32"), aluminum, anodized	1		30034
	Bracker connector, steel, zinc-plated	1	1	057.3051.101
	Screw, M4x2.6 mm (5/32"x 1/8"), steel, zinc-plated	2	2	011.0101.171
	Panel end component B, right, 53 mm (2 3/32"), aluminum, anodized		1	30036





**Panel end component set, 60 mm (2 3/8"), aluminum, for running track 27671, 27672, 27673, 27695, 30323, 30324 in combination with spacer track 057.3054.xxx**

		No.
Panel end component set, left, 60 mm (2 3/8"), anodized		30147
Panel end component set, right, 60 mm (2 3/8"), anodized		30148

		30147	30148	No.
<b>Set consisting of:</b>				
	Panel end component B, left, 60 mm (2 3/8"), aluminum, anodized	1		30030
	Bracker connector, steel, zinc-plated	1	1	057.3051.101
	Screw, M4x2.6 mm (5/32"x 1/8"), steel, zinc-plated	2	2	011.0101.171
	Panel end component B, right, 60 mm (2 3/8"), aluminum, anodized		1	30035





**Panel end component set, 95 mm (3 3/4"), can be shortened, aluminum, for running track 30613, 30614, 30615, 30616, 30666, 30667**

		No.
Panel end component set, left, 95 mm (3 3/4"), aluminum, anodized		30434
Panel end component set, right, 95 mm (3 3/4"), aluminum, anodized		30435

		30434	30435	No.
<b>Set consisting of:</b>				
	Panel end component, left, 95 mm (3 3/4"), aluminum, anodized, can be cut to size	1		30131
	Bracker connector, steel, zinc-plated	1	1	057.3051.101
	Screw, M4x2.6 mm (5/32" x 1/8"), steel, zinc-plated	2	2	011.0101.171
	Panel end component, right, 95 mm (3 3/4"), aluminum, anodized, can be cut to size		1	30398

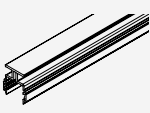
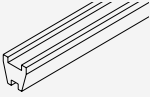

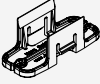

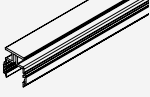
**Hawa Adapto 80/100 concrete casting system, without fixed glazing**

	No.
Inset profile for concrete surfaces Hawa Adapto 80, without fixed glass, 2500 mm (8' 2 7/16")	20216
Inset profile for concrete surfaces Hawa Adapto 80, without fixed glass, 4000 mm (13' 1 15/32")	20217





Set consisting of:		mm (inch)	20216	20217	No.
	Inset profile for concrete surfaces, without fixed glass, aluminum	2,500 (8' 2 7/16")	1		20087
	Polystyrene insert, without fixed glass	1,000 (3' 3 3/8 ")	2	4	19418
	Polystyrene insert, without fixed glass	500 (1' 7 11/16")	1		19556
	Assembly clips, plastic, black, without fixed glass		4	5	19344
	Cover cap, without fixed glass, plastic, gray		2	2	19366
	Inset profile for concrete surfaces, without fixed glass, aluminum	4,000 (13' 1 15/32")		1	20088

**Assembly set for Hawa Adapto 80/100**

	No.
Assembly set, with countersunk head screw, length up to 2500 mm (8' 2 7/16")(8' 2 7/16")	22841
Assembly set, with countersunk head screw, length 2501–4000 mm (8' 2 15/32" to 13' 1 15/32")	22842

Set consisting of:		22841	22842	No.
	Distance plate, plastic, 1 mm (1/32")	2	2	19398
	Distance plate, plastic, 2 mm (3/32")	2	2	19399
	Distance plate, plastic, 3 mm (1/8")	2	2	19400
	Distance plate, plastic, 5 mm (3/16")	4	4	19401
	Countersunk screws, 6x20 mm (1/4"x25/32"), 10-piece set	1	2	22844

**Accessories**

	No.	
	Cover cap to running track, both sides, steel, stainless steel look	24957
	Cover cap to running track, both sides, steel, chrome-plated, matt	24956
	Bottom door stopper, with centering, stainless steel look	21473
	Bottom door stopper, with centering, chrome-plated, matt	20773
	Bottom guide, rattle proof, groove width 10 mm (13/32"), plastic, black, 10-piece set	25958

Further installation examples

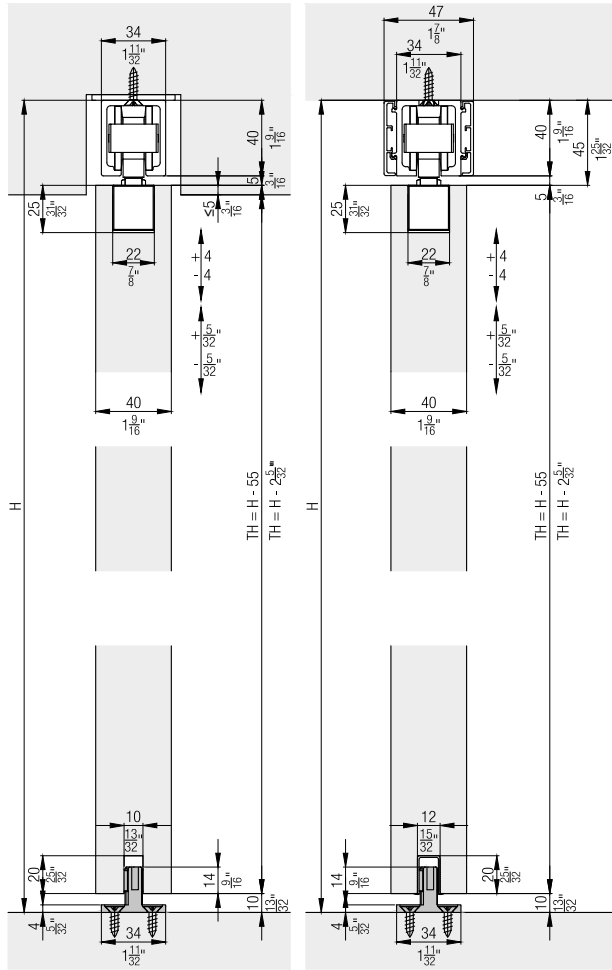

Further installation examples with spacer track

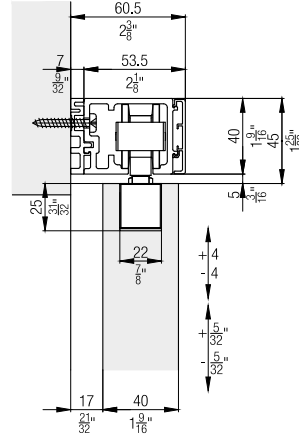

Calculations of clip-on panels

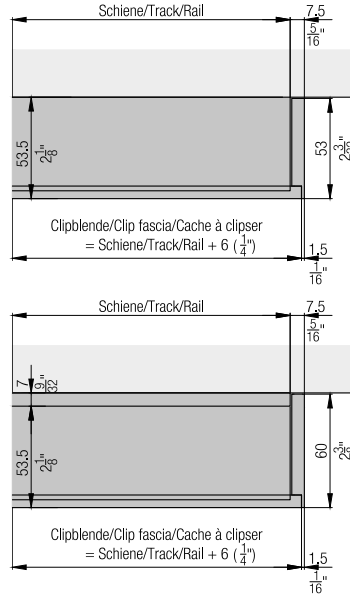

Further installation examples

Wall mounting rails with extended spacing of +11 mm/+20 mm (7/16"/25/32") between door and wall.

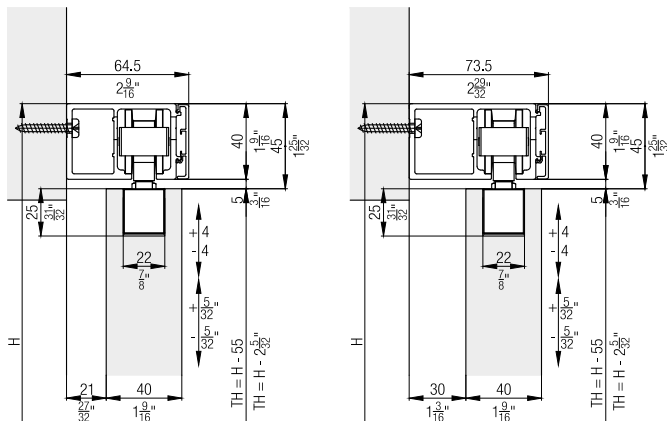

Hawa Adapto 80/100 concrete casting system

The Hawa Adapto 80/100 concrete casting system can be easily and efficiently integrated into the building shell and allows Hawa Junior 80/100 running tracks to be installed flush with the ceiling.

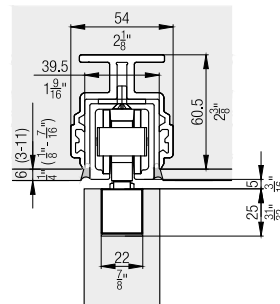

**Ceiling integration**

Recommendation: For systems integrated into the ceiling, provide assembly openings or front access to the system – front access of SoftMove is always mandatory.

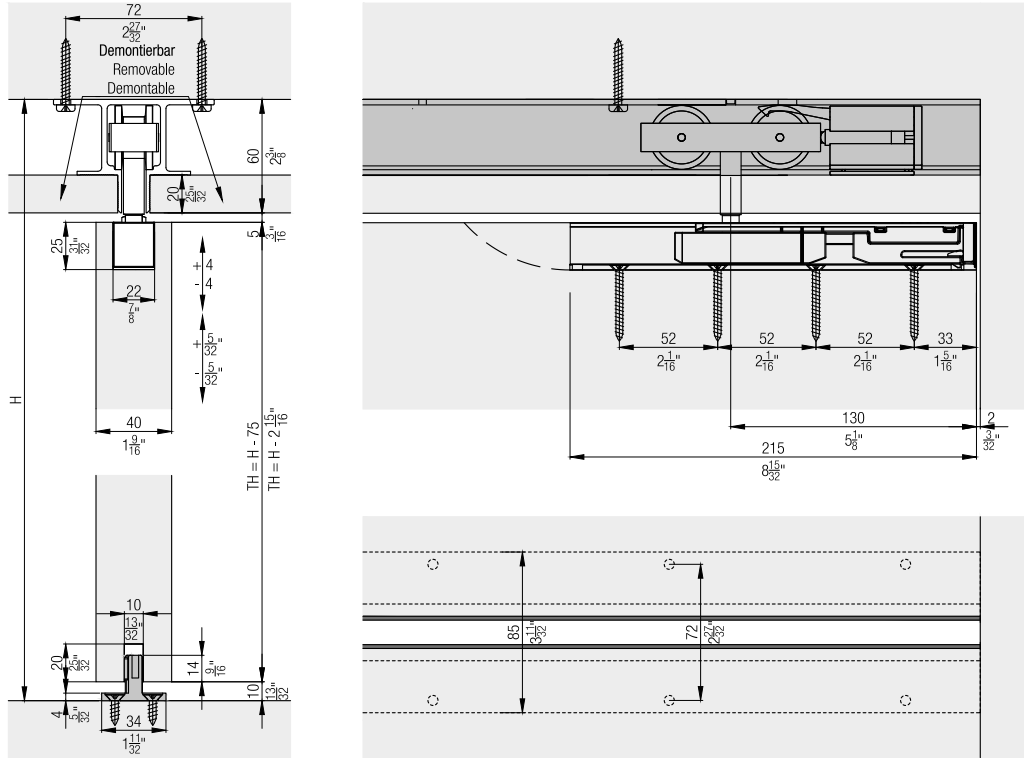

**Hawa Confort 120**

The convenient solution to an old problem. Inadequate fastening options in brittle sub-floors or in the area of floor heating. This bottom guide is mounted on the wall.

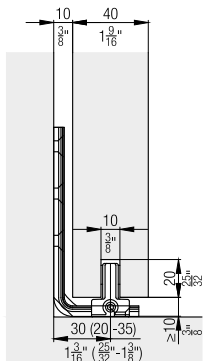

**Version with 20 mm (25/32") longer hanger bolt**

Thanks to the set No. 30153, the running track can be covered from below, using removable ceiling elements.

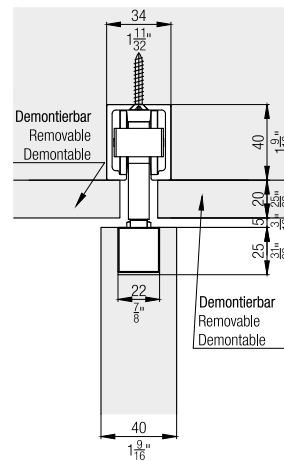

**Magnet-Dämpfeinzug Soft Move 100**

Completely integrated into the running track, the SoftMove decelerates sliding doors and draws them into their final position.

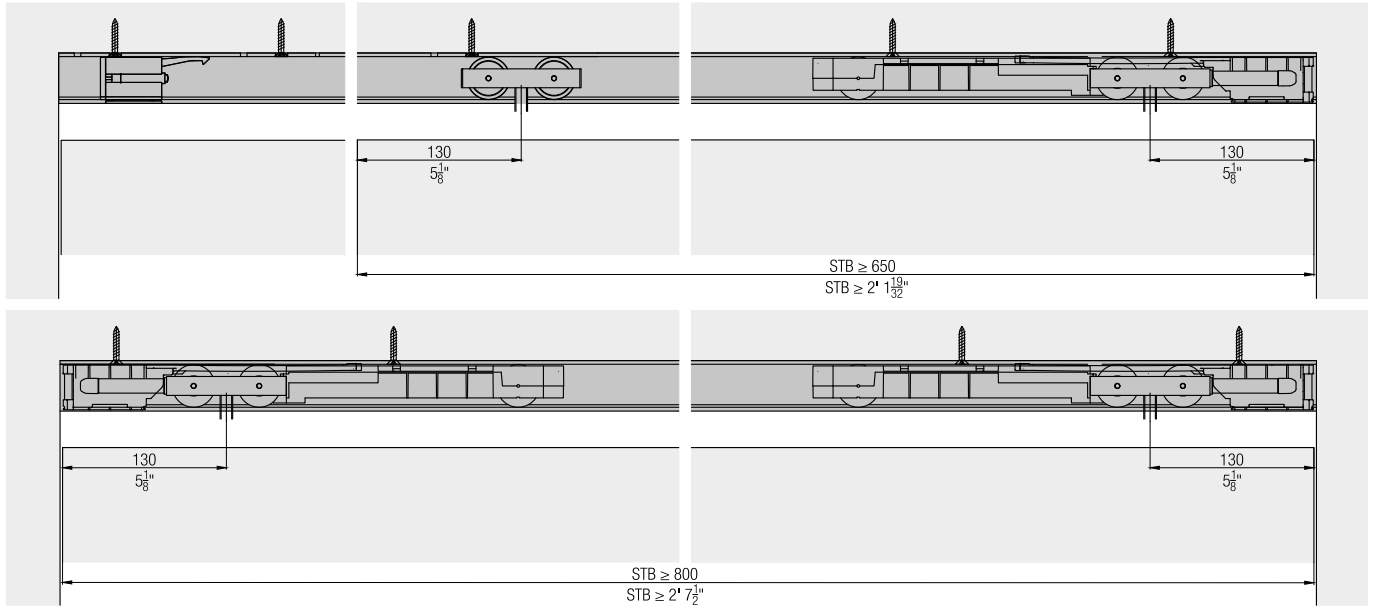

**Accessories**

- Hawa Junior bottom guides for wall mounting from page 508
- Lock solutions from page 511
- General accessories from page 518

**Planning/execution**

Further information about the product can be found on [www.hawa.com](http://www.hawa.com).