







Fitting for 2-3 top-running wooden doors up to 36 kg (79 lbs.), with groove mounted running track. With soft and self closing mechanism. Design Mixslide.

Product highlights

-  **Comfort** Quiet, smooth running and soft and self closing system for different door weights
-  **Productivity** Easy installation with tool-less clip-on system and convenient height adjustment

Technical specifications

-  Max. 36 kg (79 lbs.)
-  Max. 2400 mm (7'10 7/16")
-  Max. 1000 mm (3'3 3/8")
-  25 mm (31/32")

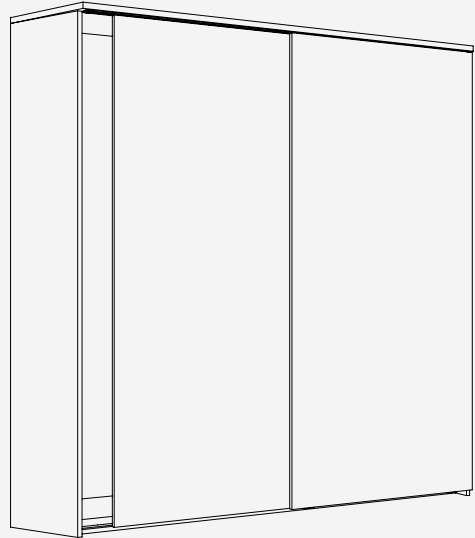

Installation examples

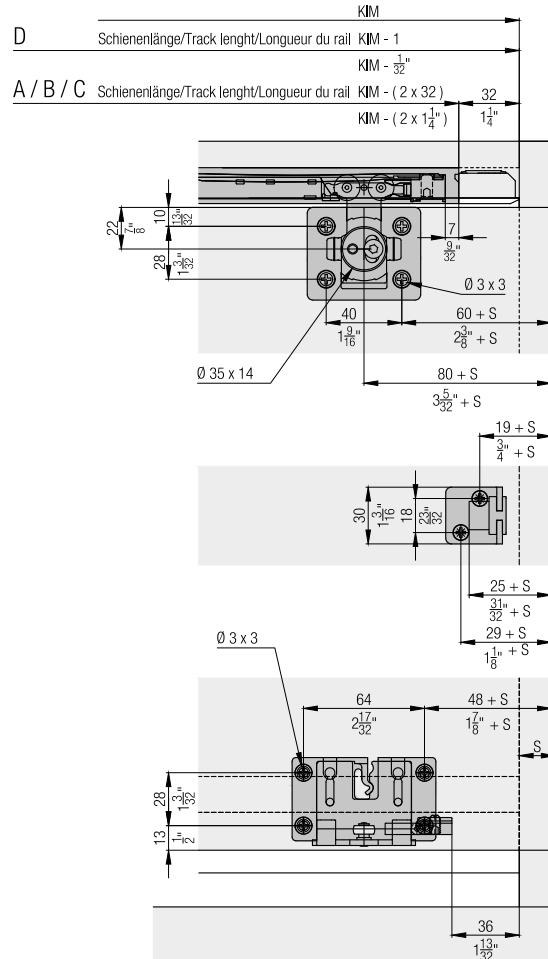
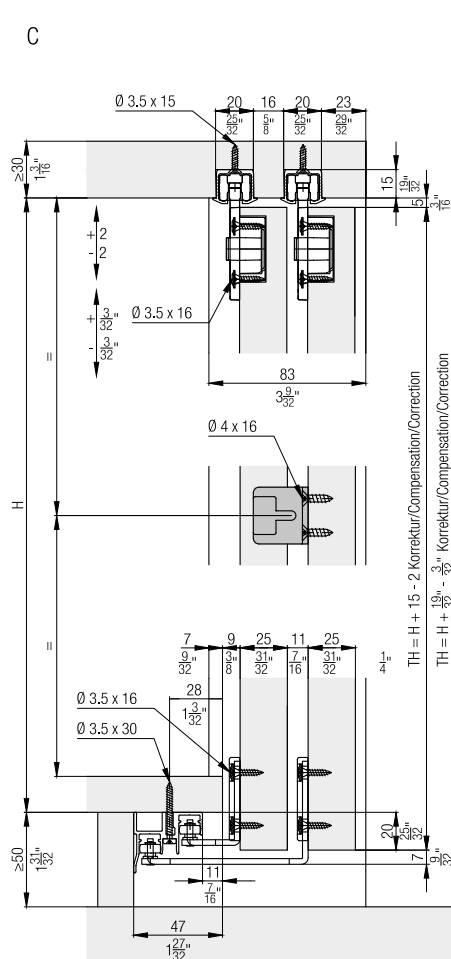

**Set for 2 wooden doors up to 36 kg (79 lbs.),
with height adjustment**

	No.
Hawa Clipo 36 H MS, for 2 doors	053.3357.071

Set consisting of:		053.3357.071	No.
	Running gear double, left	2	053.3346.071
	Running gear double, right	2	053.3347.071
	Stopper, plastic, gray	4	057.3148.071
	Housing, plastic	4	053.0332.001
	Fillister head screw, 3.5x16 mm (5/32"x5/8"), steel, zinc-plated	32	766.6052.100
	Follower Hawa Combino/Hawa Clipo, plastic	1	055.3123.071
	Adapter to follower steel, zinc-plated	1	055.0213.101
	Flat countersunk head chipboard screw 4x16 mm (5/32"x5/8"), steel, zinc-plated	2	600.0000.253
	Guide bracket, interior door, steel, zinc-plated	2	055.3107.171
	Guide bracket, exterior door, 25 mm (31/32"), steel, zinc-plated	2	055.3110.171
	Guide bracket housing, plastic, anthracite	4	053.3064.001
	Stopper guide, plastic, gray	4	040.3079.074

**Set for 3 wooden doors up to 36 kg (79 lbs.),
with height adjustment**

	No.
Hawa Clipo 36 H MS, for 3 doors	053.3357.072

Set consisting of:		053.3357.072	No.
	Running gear double, left	3	053.3346.071
	Running gear double, right	3	053.3347.071
	Stopper, plastic, gray	4	057.3148.071
	Housing, plastic	6	053.0332.001
	Fillister head screw, 3.5x16 mm (5/32"x5/8"), steel, zinc-plated	48	766.6052.100
	Buffer, with adhesive	2	061.3083.001
	Guide bracket, interior door, steel, zinc-plated	4	055.3107.171
	Guide bracket, exterior door, 25 mm (31/32"), steel, zinc-plated	2	055.3110.171
	Guide bracket housing, plastic, anthracite	6	053.3064.001
	Door follower, steel, zinc-plated, with 3 doors	2	055.3126.171
	Thread-cutting rounded head screw, M4x8 mm (5/32"x5/16"), steel, zinc-plated	2	600.0000.328
	Stopper guide, plastic, gray	4	040.3079.074



Running tracks

		mm (inch)	No.
	A: Single running track, for glue fixing, aluminum, anodized	2,500 (8' 2 7/16")	053.3324.250
		3,500 (11' 5 25/32")	053.3324.350
		6,000 (19' 8 7/32")	053.3324.600
	B: Single running track, swivel lug, aluminum, anodized (not for hard wood/ MDF)	2,500 (8' 2 7/16")	053.3327.250
		3,500 (11' 5 25/32")	053.3327.350
		6,000 (19' 8 7/32")	053.3327.600
	C: Single running track, for screw fixing, aluminum, anodized	2,500 (8' 2 7/16")	053.3325.250
		3,500 (11' 5 25/32")	053.3325.350
		6,000 (19' 8 7/32")	053.3325.600
	D: Double running track, for screw fixing, aluminum, anodized, for door thickness of 25 mm (31/32")	2,500 (8' 2 7/16")	053.3328.250
		3,500 (11' 5 25/32")	053.3328.350
		6,000 (19' 8 7/32")	053.3328.600

Track end piece set for single running tracks

	No.
Track-end section, for screw fixing, plastic, gray, 2-piece set	053.3354.071
Track-end section, swivel lug, plastic, gray, 2-piece set	053.3355.051

Set consisting of:

	053.3354.071	053.3355.051	No.
 Track-end piece, for screw fixing, plastic	2		053.0334.001
 Chipboard screw, 4x12 mm (5/32"x15/32"), steel, zinc-plated	2		600.0000.704
 Track-end piece, with swivel lug, plastic		2	053.3351.071

Guide tracks

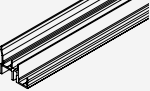
		mm (inch)	No.
	Double guide track, for screw fixing, aluminum, anodized, pre-drilled	2,500 (8' 2 7/16")	056.3072.250
		3,500 (11' 5 25/32")	056.3072.350
		6,000 (19' 8 7/32")	056.3072.600

Soft close up to 15/26/36 kg (33/57/79 lbs.)

	No.
Soft close, up to 15 kg (33 lbs.)	057.3159.071
Soft close, up to 26 kg (57 lbs.)	057.3159.072
Soft close, up to 40 kg (88 lbs.)	057.3159.073

Set consisting of:

	057.3159.071	057.3159.072	057.3159.073	No.
 Soft close, up to 15 kg (33 lbs.)	2			057.3156.071
 Release piece soft close	2	2	2	057.0182.101
 Thread rolling rounded head screw, M2.5x5 mm (3/32"x3/16"), steel, zinc-plated	2	2	2	600.0000.764
 Soft close, up to 26 kg (57 lbs.)		2		057.3156.072
 Soft close, up to 40 kg (88 lbs.)			2	057.3156.073

Handle profiles

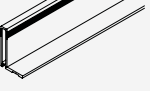
		mm (inch)	No.
	Handle profile, groove for brush seal, for screw fixing, aluminum, anodized, pre-drilled	2,500 (8' 2 7/16")	055.3140.250
		6,000 (19' 8 7/32")	055.3140.600

Accessories

		No.
	Track cleaner, plastic, red	040.3142.071

Further installation examples

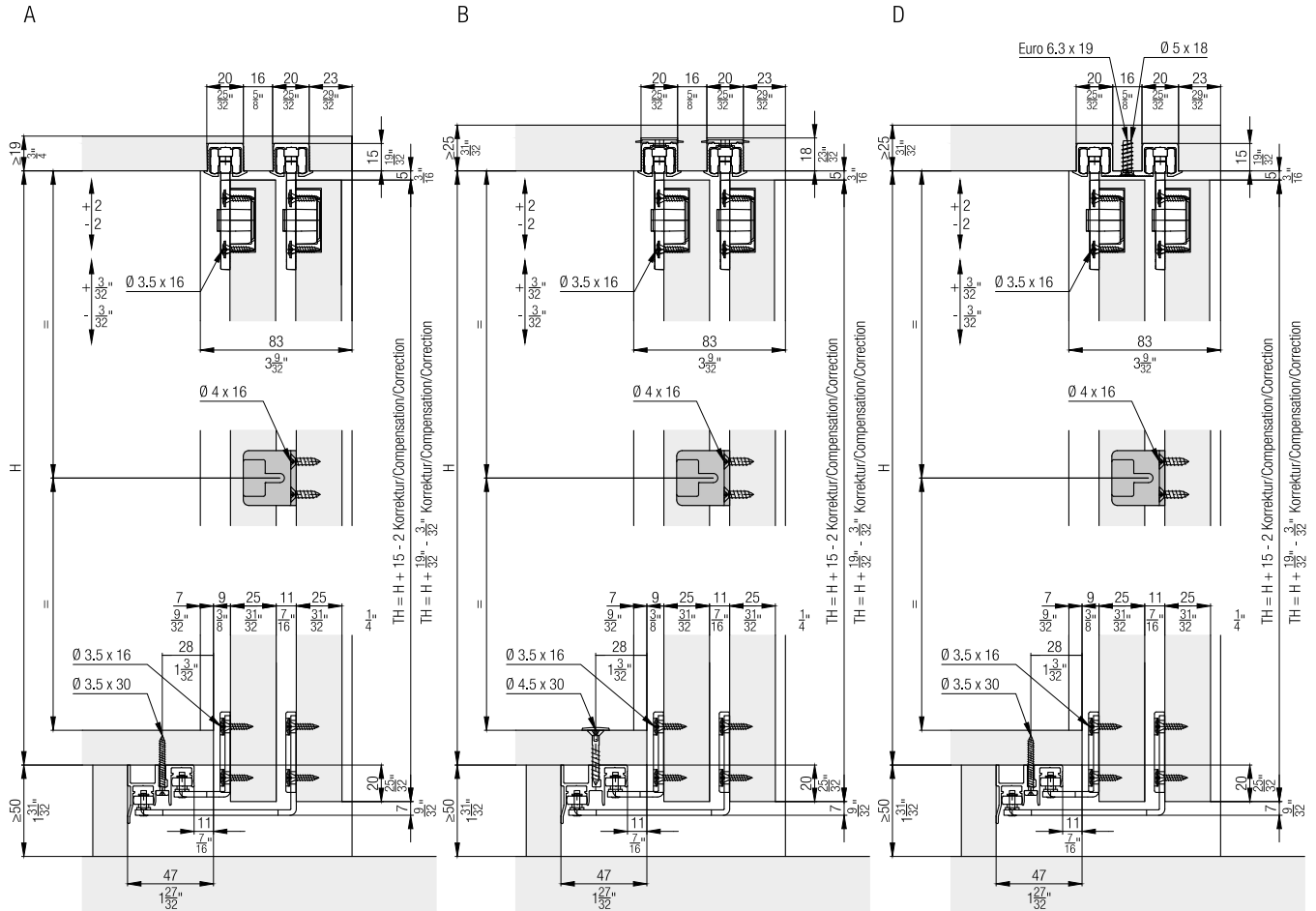

Calculations

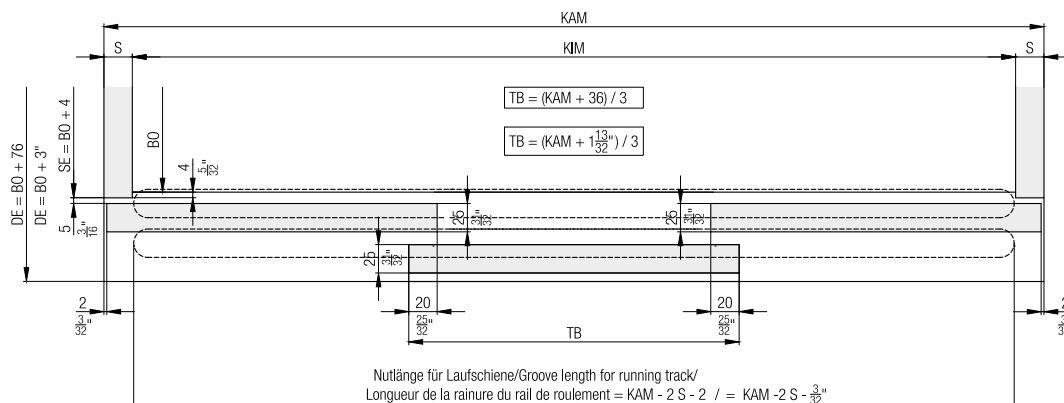
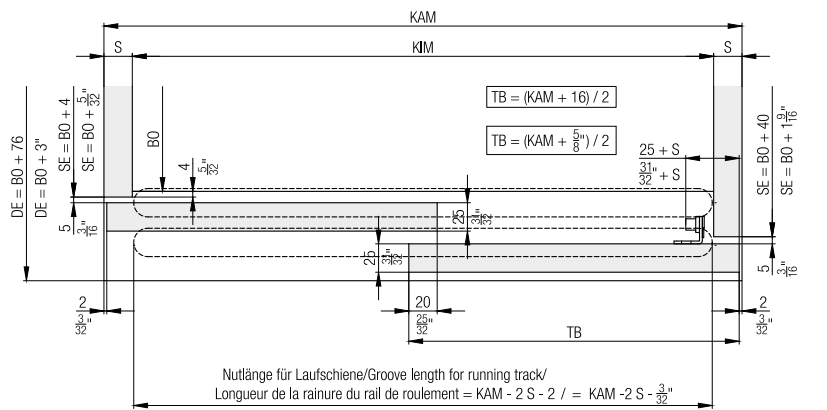

Handle profiles

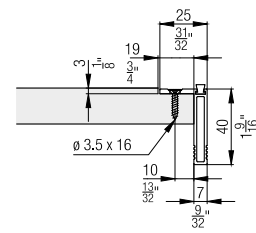

Soft close

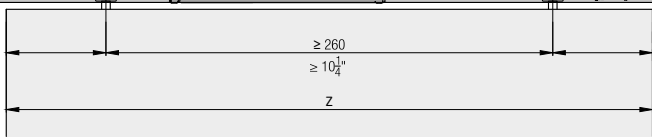
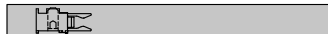

	Z ≥	
	1	2
Hawa Porta 40 H	1' 4 17/32"	2' 0 13/32"
Hawa Porta 40 GE	1' 2 13/16"	1' 10 11/16"
Hawa Clipo 26 H IS	1' 4 17/32"	2' 0 13/32"
Hawa Clipo 26 H MS	1' 6 1/32"	2' 1 29/32"
Hawa Clipo 36 H IS	1' 4 17/32"	2' 0 13/32"
Hawa Clipo 36 H MS	1' 6 31/32"	2' 1 29/32"
Hawa Clipo 36 HM IS	1' 4 17/32"	2' 0 13/32"
Hawa Clipo 26 GR IS	1' 4 17/32"	2' 0 13/32"
Hawa Clipo 36 G IS	1' 4 17/32"	2' 0 13/32"
Hawa Clipo 36 GPK IS	1' 4 17/32"	2' 0 13/32"
Hawa Clipo 36 GPPK IS	1' 4 17/32"	2' 0 13/32"
Hawa Regal C 26 HM IS	1' 4 17/32"	2' 0 13/32"
Hawa Regal C 26 GR IS	1' 3 3/4"	1' 11 5/8"

	Z ≥	
	1	2
Hawa Porta 40 H	420	620
Hawa Porta 40 GE	376	576
Hawa Clipo 26 H IS	420	620
Hawa Clipo 26 H MS	458	658
Hawa Clipo 36 H IS	420	620
Hawa Clipo 36 H MS	458	658
Hawa Clipo 36 HM IS	420	620
Hawa Clipo 26 GR IS	420	620
Hawa Clipo 36 G IS	420	620
Hawa Clipo 36 GPK IS	420	620
Hawa Clipo 36 GPPK IS	420	620
Hawa Regal C 26 HM IS	420	620
Hawa Regal C 26 GR IS	400	600

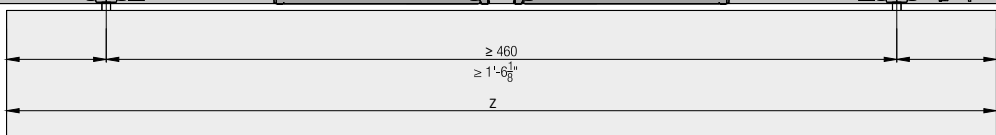

Accessories

– Straightening fitting from page 236

Planning/execution

Further information about the product can be found on www.hawa.com.