

TOP VIEW

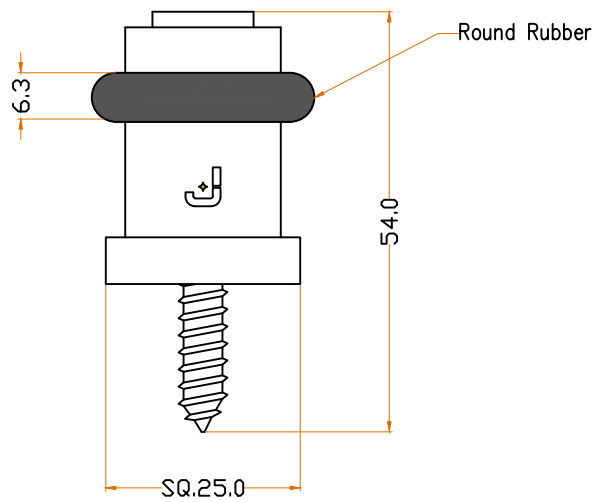

FRONT VIEW

MATERIAL	FINISH	SCALE	DESCRIPTION
BRASS	GA ,AB OS ,BK	NTS	Door Stop
PROJN.	UNIT	DATE	ITEM CODE
	MM	28.02.19	J-0260