

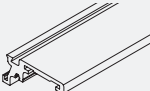











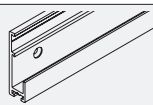

Garnitur für 1 Dreh-Einschiebetüre bis 25 kg

		Nr.			
Hawa Concepta 25, für 1 Türe		27648			
		27648	Nr.		
Garnitur bestehend aus:					
	Holm, 1800 mm, Aluminium, eloxiert			1	22055
	Holmführung, spielfrei, mit Kunststoffrollen			2	25656
	Torsionsplatte			1	27704
	Schere komplett, 900 mm, Stahl, verzinkt			1	22592
	Scherenführung vorne, Aluminium, eloxiert			1	25592
	Scherenführung hinten, Aluminium, eloxiert			1	25596
	Scherenlager hinten, 55 mm, Stahl, verzinkt			1	25855
	Topfscharnier, mit Dämpfung, Stahl, vernickelt, Set à 3 Stück			1	27654
	Schrauben-Set für Topfscharniere, 4x16 mm, Set à 10 Stück			1	25935
	Distanzprofil, 860 mm, gelocht, Kunststoff, schwarz	1	22861		
	Schraubenset zu Distanzprofil, PH 4x16 mm, Set à 7 Stück	1	25562		
	Bürstenführung, Kunststoff, schwarz, Set à 3 Stück	1	25815		

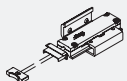
Fortsetzung Tabelle auf nächster Spalte

Fortsetzung Tabelle von vorheriger Spalte

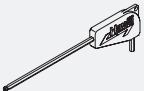
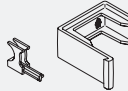
	Führungsschiene, 728 mm, Aluminium, eloxiert, gelocht	2	24533
	Anschlagabdeckkappe Hawa Concepta, tiefenverstellbar, oben links/unten rechts	1	27657
	Anschlagabdeckkappe Hawa Concepta, tiefenverstellbar, oben rechts/unten links	1	27658
	Abdeckkappen, Edelstahl, 1 Paar	1	24739
	Anschlagdämpfer, mit Haltebügel	1	24661
	Türeinzug 25/50, mit Endlagendämpfung, Kunststoff, schwarz	1	25814
	Endlagendämpfung, mit Abdeckkappen, Kunststoff, schwarz	1	25862
	Schraubenset, 4,5x20 mm, Set à 22 Stück	1	22451
	Inbusschlüssel, mit Griff, 3 mm	1	13164
	Montagehilfe, Kunststoff, rot	1	25816

Korpus Verbindungsprofile

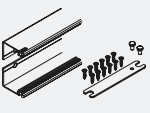
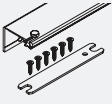
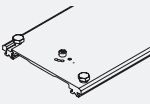
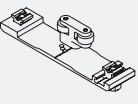
		mm	Nr.
	Connector 55 mm, für eine Dreh-Einschiebetüre, Aluminium, eloxiert, 2 Stück	650	25438
	Connector 55 mm, für eine Dreh-Einschiebetüre, Aluminium, eloxiert, 1 Stück	650	23221
		900	23222
	Connector 110 mm, für zwei Dreh-Einschiebetüren, Aluminium, eloxiert, 1 Stück	650	23223
		900	23224
	Connector 110 mm, für zwei Dreh-Einschiebetüren, Aluminium, eloxiert, 1 Stück (für Montage vor fixem Sockel)	26	23225

Führungen

		Nr.
	Führung für zwei einliegende Dreh-Einschiebetüren, Aluminium	25680

Türgriffe

		mm	Nr.
	Türgriff, Aluminium, eloxiert	400	22692

Türgriffhöhe

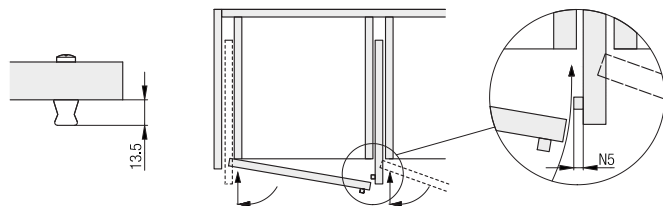

Weitere Einbaubeispiele
Türe einliegend

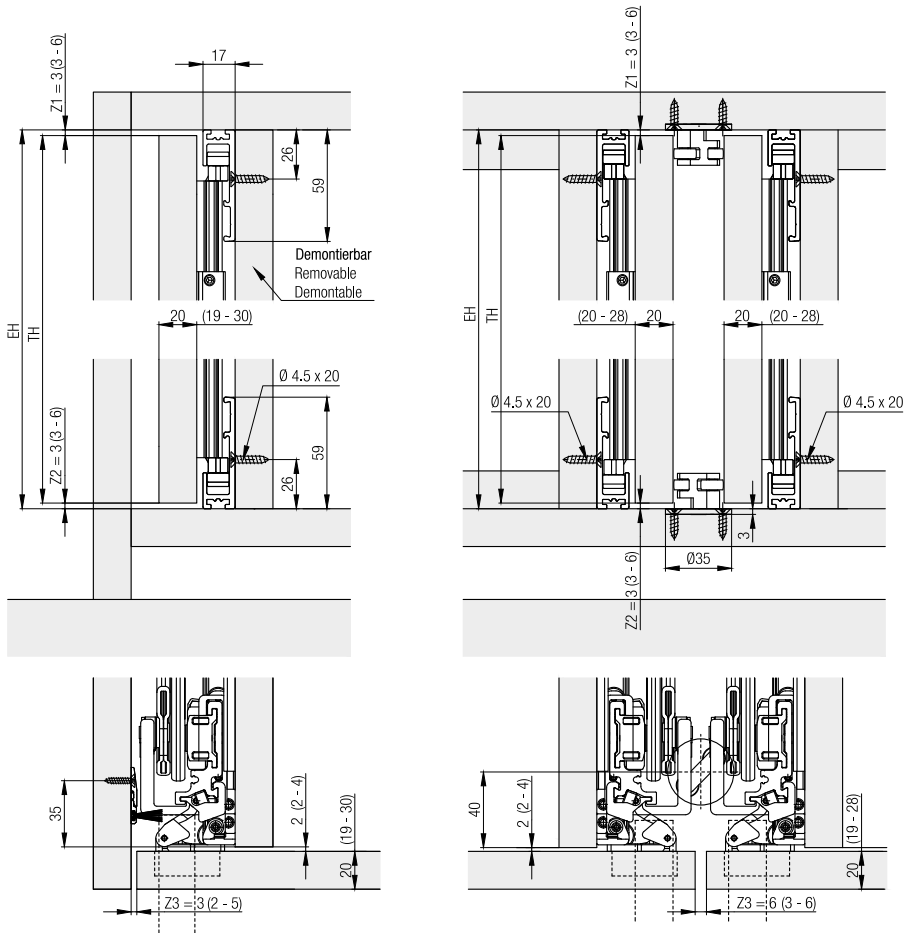

Türe in Mauernische

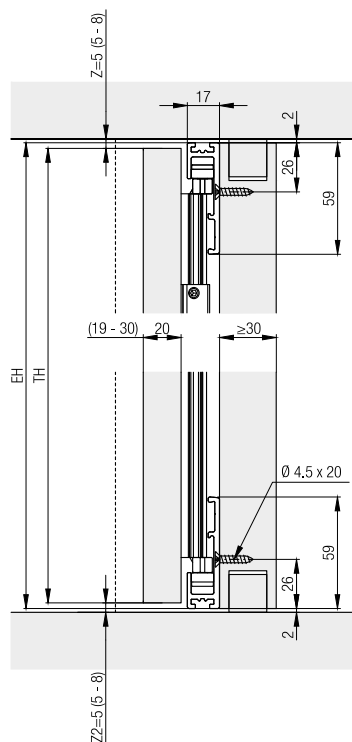

Türdicke 31-50 mm

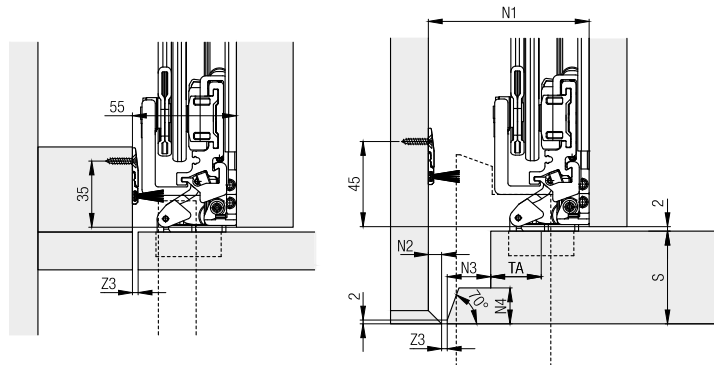

S	N1	N2	N3	N4
19-30 mm	55 mm	0 mm	0 mm	0 mm
33 mm	58 mm	0 mm	3 mm	3 mm
36 mm	63 mm	2 mm	6 mm	5 mm
39 mm	67 mm	3 mm	9 mm	8 mm
42 mm	70 mm	3 mm	12 mm	11 mm
45 mm	75 mm	5 mm	15 mm	14 mm
48 mm	79 mm	6 mm	18 mm	17 mm
50 mm	83 mm	7 mm	21 mm	19 mm

Berechnung Beschlagtiefe

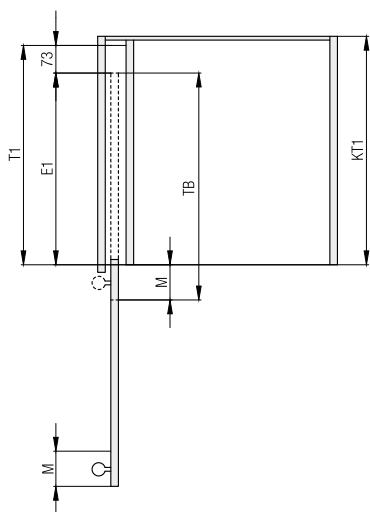

$$T1 = TB - M + 73 \text{ mm}$$

$$E1 = T1 - 73 \text{ mm}$$

	T1	TH	E1
Hawa Concepta 25	≤ 650 mm	1250 - 1850 mm	300 - 577 mm

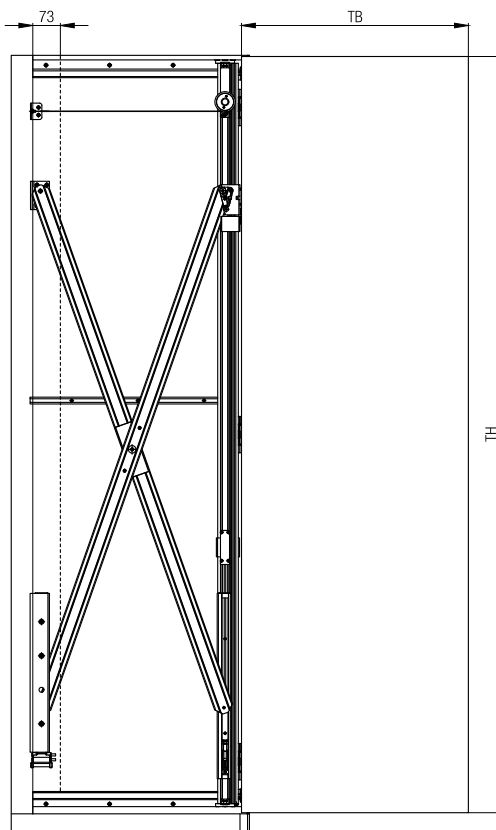

Berechnungen Gewicht- und Türgrößenverhältnis

Das Maximale Gewicht muss je nach Türgrößenverhältnis angepasst werden.

TH \ TB	300	350	400	450	500	550	600	650	700	750
1850	25	25	25	25	25	25	25	24	23	22
1800	25	25	25	25	25	25	25	23	22	21
1750	25	25	25	25	25	25	24	22	21	21
1700	25	25	25	25	25	25	24	21	21	20
1650	25	25	25	25	25	25	23	21	20	19
1600	25	25	25	25	25	24	22	20	19	18
1550	25	25	25	25	25	24	21	19	18	18
1500	25	25	25	25	25	23	21	18	18	17
1450	25	25	25	25	24	22	20	18	17	16
1400	25	25	25	25	24	21	19	17	16	15
1350	25	25	25	24	23	21	18	19	16	15
1300	25	25	25	24	22	20	18	15	15	14
1250	25	25	24	23	21	19	17	15	14	13

Türgewicht in kg | TB = Türbreite in mm | TH = Türhöhe in mm

Zubehör

– Ausrichtbeschlag ab Seite 228

Planung/Ausführung

Konfigurieren Sie mit nur wenigen Klicks auf www.concepta.hawa.com

Weitere Informationen zum Produkt finden Sie auf www.hawa.com.