

**Fitting for 2–3 bottom-running wooden doors (19/25 mm) up to 50 kg (110 lbs.) with screwed on running track and integrated soft close. Design Forslide.**

**Product highlights**



**Comfort**

Sophisticated soft closing system and innovation arrangement of the components for very easy operation



**Aesthetics**

Bottom-running system that supports the entire door weight on the base makes cabinet designs with thin materials possible

**Technical specifications**



Max. 50 kg (110 lbs.)



Max. 2400 mm (7'10 7/16")



Max. 1400 mm (4'7 1/8")



19/25 mm (3/4" or 31/32")

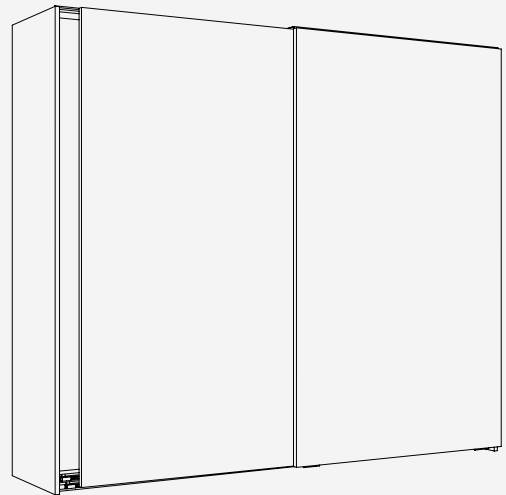

**Installation examples**

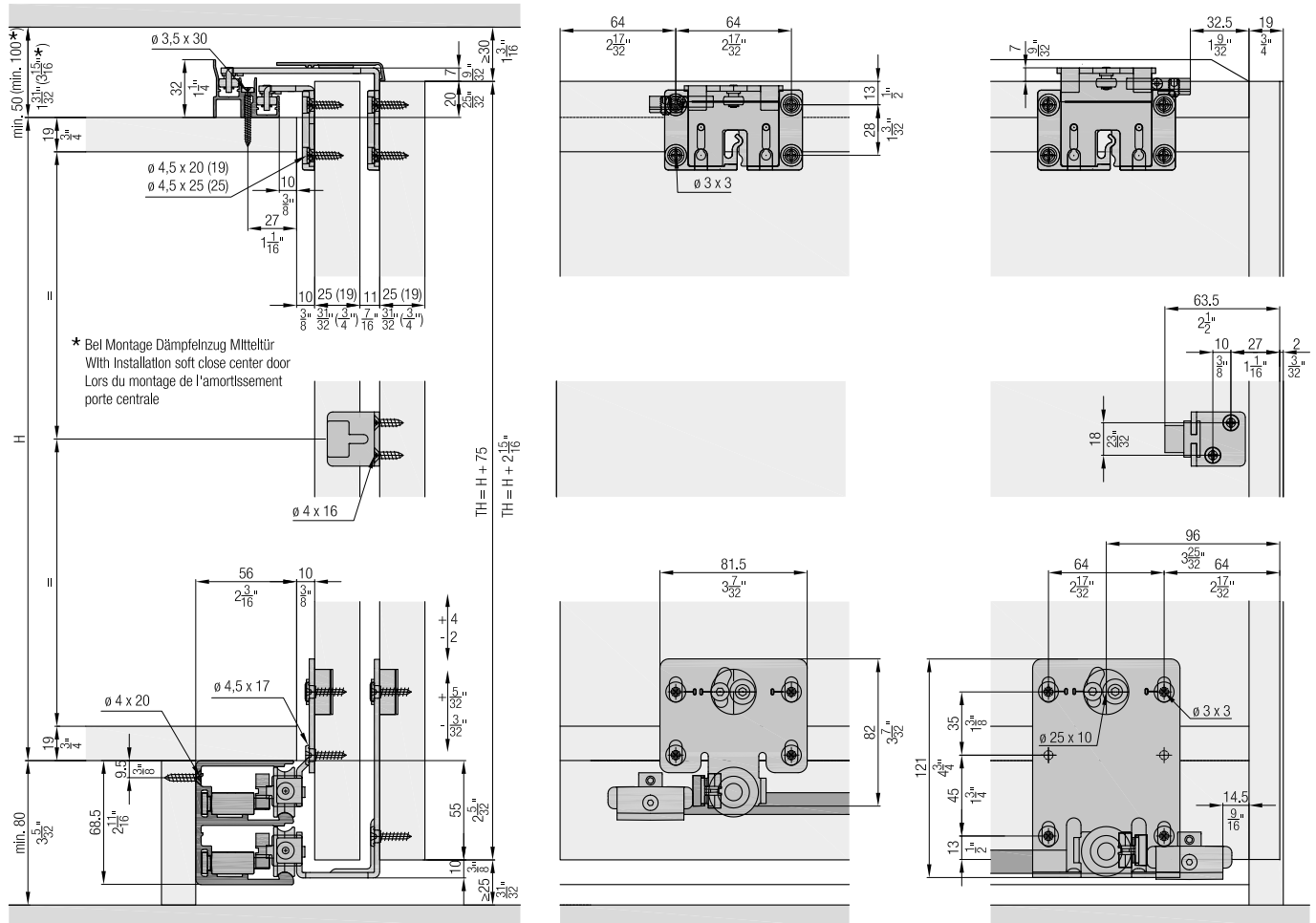

**Set for 2 or 3 wooden doors, 19 mm (3/4")**

	No.
Hawa Combino 50 H FS, door thickness 19 mm (3/4"), for 2 doors	055.3200.071
Hawa Combino 50 H FS, door thickness 19 mm (3/4"), for 3 doors	055.3200.073

Set consisting of:	055.3200.071		055.3200.073		No.
 Running gear, interior door, steel, zinc-plated	2	4			055.3169.071
 Running gear, exterior door, 19 mm (3/4"), steel, zinc-plated	2	2			055.3113.175
 Guide bracket, interior door, steel, zinc-plated	2	4			055.3107.171
 Guide bracket, exterior door, 19 mm (3/4"), steel, zinc-plated	2	2			055.3109.171
 Guide bracket housing, plastic, anthracite	4	6			055.0282.001
 Stopper, plastic, gray	4	4			055.3167.071
 Retention spring for stopper, plastic, gray	2	3			055.0204.001
 Stopper guide, plastic, gray	4	4			040.3079.074
 Door follower, with 2 doors, steel, zinc-plated	1				055.3124.071
 Washer and screw assembly, 4.5x17 mm, steel, zinc-plated	16	24			055.0100.101
 Countersunk head screw, 4.5x20 mm, steel, zinc-plated	16	24			600.0000.167
 Door follower, with 3 doors, steel, zinc-plated			2		055.3126.171
 Buffer, with adhesive, 2-piece set			1		053.3364.051
 Thread-cutting rounded head screw, M4x8 mm, steel, zinc-plated			2		600.0000.328

**Set for 2 or 3 wooden doors, 25 mm (31/32")**

	No.
Hawa Combino 50 H FS, door thickness 25 mm (31/32"), for 2 doors	055.3200.072
Hawa Combino 50 H FS, door thickness 25 mm (31/32"), for 3 doors	055.3200.074

Set consisting of:	055.3200.072		055.3200.074		No.
 Running gear, interior door, steel, zinc-plated	2	4			055.3169.071
 Running gear, exterior door, 25 mm (31/32"), steel, zinc-plated	2	2			055.3114.175
 Guide bracket, interior door, steel, zinc-plated	2	4			055.3107.171
 Guide bracket, exterior door, 25 mm (31/32"), steel, zinc-plated	2	2			055.3110.171
 Guide bracket housing, plastic, anthracite	4	6			055.0282.001
 Stopper, plastic, gray	4	4			055.3167.071
 Retention spring for stopper, plastic, gray	2	3			055.0204.001
 Stopper guide, plastic, gray	4	4			040.3079.074
 Door follower, with 2 doors, steel, zinc-plated	1				055.3124.071
 Washer and screw assembly, 4.5x17 mm, steel, zinc-plated	16	24			055.0100.101
 Countersunk head screw, 4.5x25 mm, steel, zinc-plated	16	24			766.5045.125
 Door follower, with 3 doors, steel, zinc-plated			2		055.3126.171
 Buffer, with adhesive, 2-piece set			1		053.3364.051
 Thread-cutting rounded head screw, M4x8 mm, steel, zinc-plated			2		600.0000.328

**Running tracks**

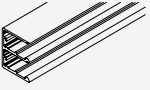
		mm (inch)	No.
	Double running track, aluminum, anodized, pre-drilled, for soft close	2500 (8'2 7/16")	055.3160.250
		3500 (11'5 25/32")	055.3160.350
		6000 (19'8 7/32")	055.3160.600

**Guide tracks**

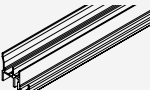
		mm (inch)	No.
	Double guide track, aluminum, anodized, pre-drilled	2500 (8'2 7/16")	056.3072.250
		3500 (11'5 25/32")	056.3072.350
		6000 (19'8 7/32")	056.3072.600

**Stopper extension**

For use without soft close order 4 pieces



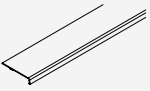

		No.
	Stopper extension, plastic, gray	055.3168.071

**Panels**

		mm (inch)	No.
	Cover panel, aluminum, anodized	2500 (8'2 7/16")	055.3130.250
		3500 (11'5 25/32")	055.3130.350
		6000 (19'8 7/32")	055.3130.600







**Soft close**

		No.
Hawa Combinio 50 H MS/FS, up to 50 kg (110 lbs.), 2 pieces		055.3215.071
Hawa Combinio 50 H MS/FS, up to 50 kg (110 lbs.), 4 pieces		055.3215.072

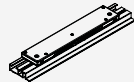
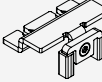
		055.3215.071	055.3215.072	No.
<b>Set consisting of:</b>				
	Soft close, left, up to 50 kg (110 lbs.)	1	2	055.3166.072
	Soft close, right, up to 50 kg (110 lbs.)	1	2	055.3166.071
	Activator soft close	2	4	055.3165.071
	Stopper extension, plastic, gray	2		055.3168.071
	Thread-cutting head screw, M4x8 mm, steel, zinc-plated	2	4	600.0000.344

**Soft close center door**

		No.
Hawa Combinio 50 H FS, center door		055.3216.071

		055.3216.071	No.
<b>Set consisting of:</b>			
	Soft close, center door	1	055.3193.071
	Activator, center door soft close	1	055.3195.071
	Safety device for guide bracket, plastic, anthracite	1	053.3099.001
	Rubber buffer, plastic, transparent	2	055.0318.001
	Fillister head screw, 4x16 mm, steel, zinc-plated	2	600.0000.166
	Countersunk head screw, 4.5x20 mm, steel, zinc-plated	1	600.0000.167
	Thread-cutting rounded head screw, M4x8 mm, steel, zinc-plated	2	762.7009.100

Calculations

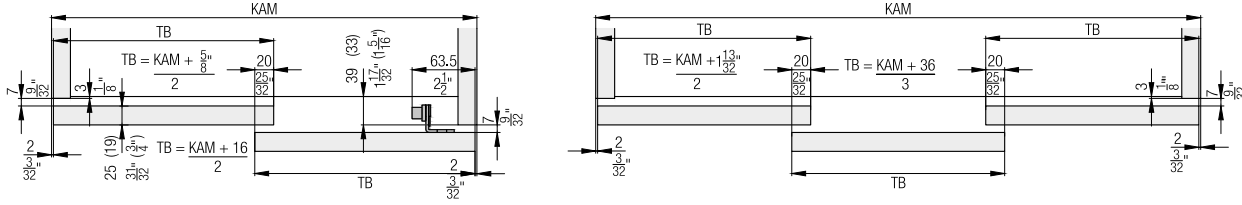

Center door soft close for 3 doors

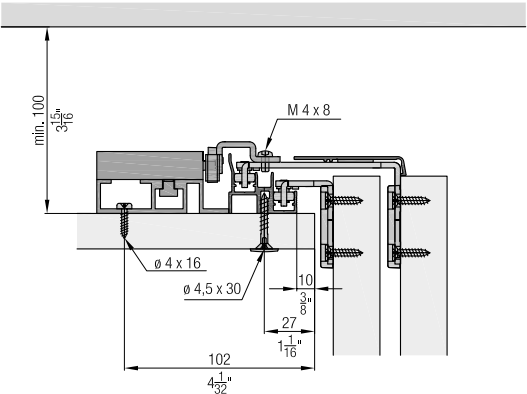

Handle profiles

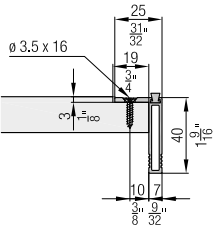

**Soft close**

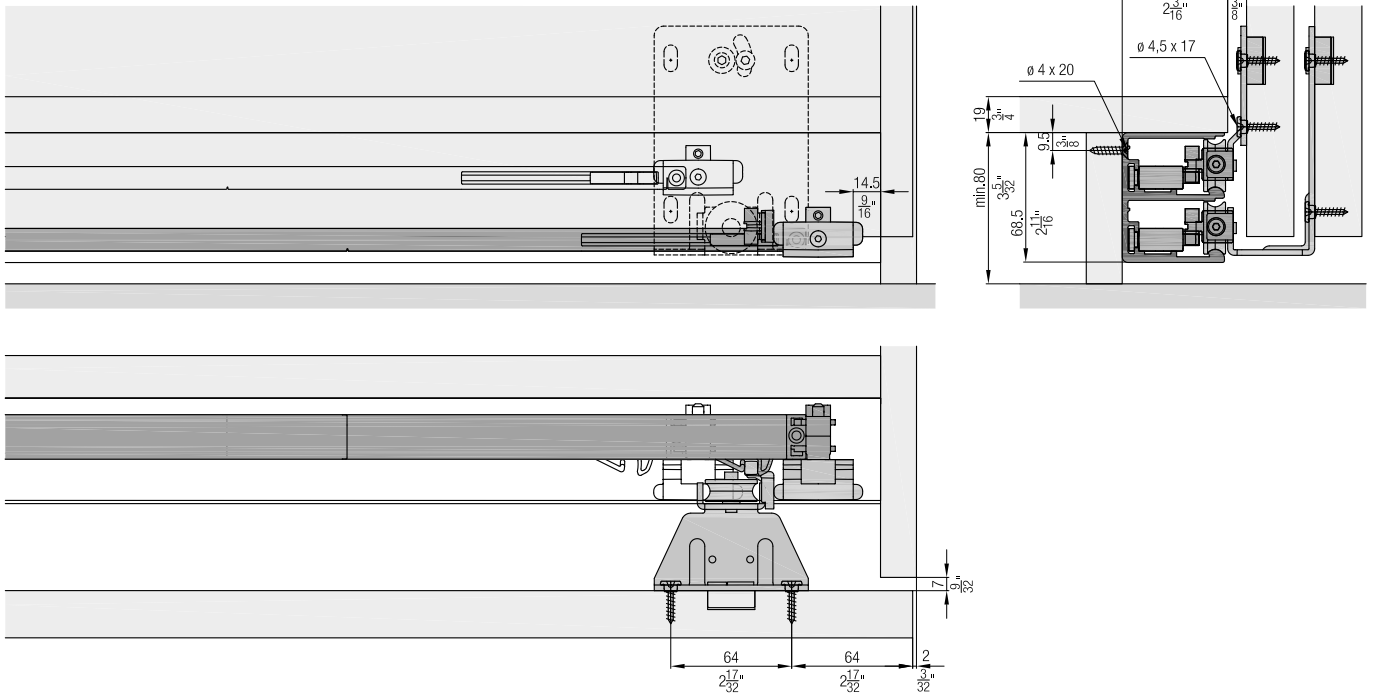

**Accessories**

- Straightening fitting from page 266
- Handle profiles from page 268
- Order overview soft close from page 270

**Planning/execution**

Further information about the product can be found on [www.hawa.com](http://www.hawa.com).